

# INSTALLATION INSTRUCTIONS CARE AND MAINTENANCE

*American Standard*  
Style That Works Better

## Princeton™ Bath Models: 2394.202, 2395.202, 2396.202, 2397.202

Thank you for selecting American Standard - the benchmark of fine quality for over 100 years. To ensure this product is installed properly, please read these instructions carefully before you begin. (Certain installations may require professional help.) Also be sure your installation conforms to local codes.

### Observe Local Plumbing and Building Codes

#### 1 FRAMING INSTRUCTIONS

Note recess is 1527 x 864mm (60-1/8 x 34). Cut a 229 x 305mm (9 x 12) hole in sub floor for drain, centered 464mm (18-1/4) as shown for below floor rough. Locate studs as required, then ensure rough opening dimensions are proper and supports are plumb and square.

\* Install stringer as shown (346mm [13-5/8] for through the floor drain or 435mm [17-1/8] for above the floor drain.)

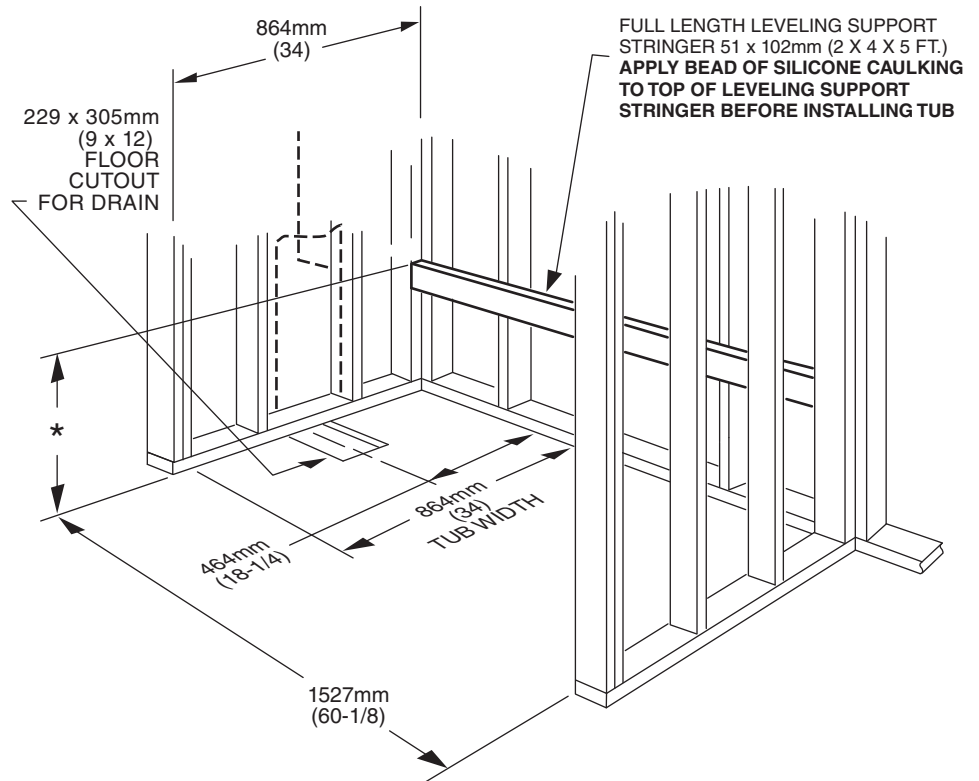

#### 2 DRAIN

Install the overflow and drain assembly onto the tub per manufacturer's instructions.

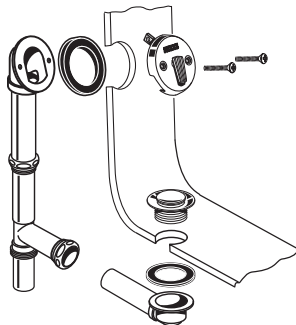

#### 3 INSTALLATION - BEDDING MATERIAL (MORTAR, SANDMIX, ETC.) IS ACCEPTABLE SUB FLOOR MUST BE STRUCTURALLY SOUND & FREE OF MOVEMENT / FLEXING

The tub is provided with an integral base for easier installation. Position the bath on the floor and slide into place until the tub is resting on the rear stringer. The base does not need to contact the floor for proper installation. The base on the 2396 and 2397 models is raised above the floor to facilitate drain installation. Check level, front to back and side to side. Also check drain clearance hole in sub floor. To secure the tub to wood studs, use sheet rock screws with washers immediately above the flange of the tub. To secure the tub to steel studs, use drywall screws and flat washers. (See Step 4)

**Caution: Take Extra Care When Driving Nails or Screws To Avoid Damaging The Tub.**

The tile or similar finished floor will be butted against the bottom of the tub apron also holding the tub in place.

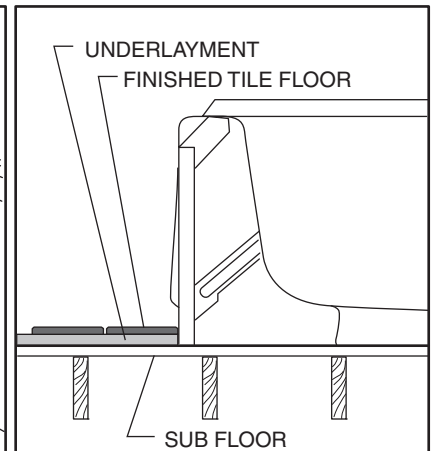
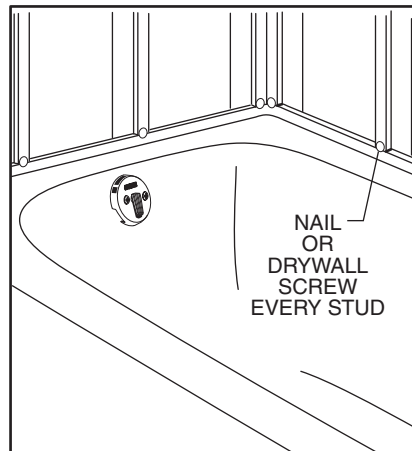

SAVE FOR FUTURE USE

**4** Below is shown typical cross sections of the tub rim showing typical wall constructions.

**WOOD STUDS**

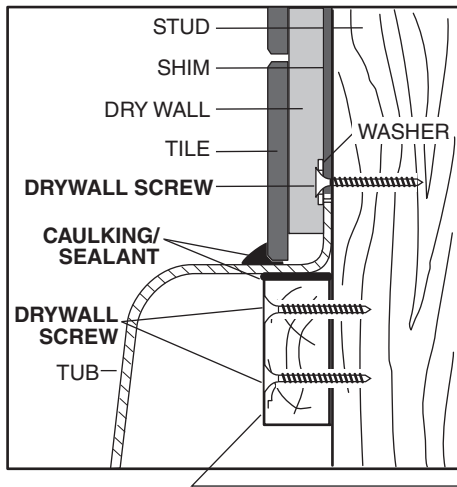

**STEEL STUDS**

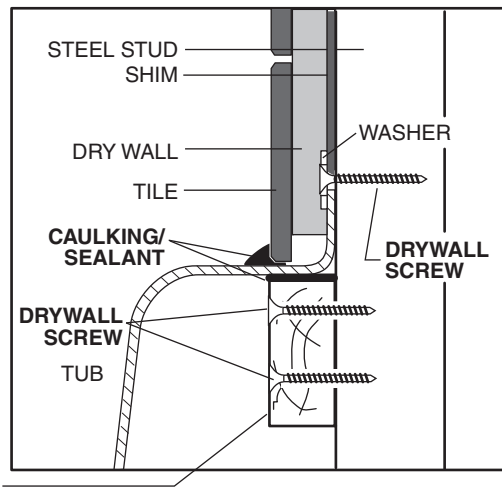

**AS AMERICA, INC. LIMITED LIFETIME WARRANTY FOR AMERICAST® PRODUCTS**

If an AS America, Inc. ("American Standard") Americast® brand product is found to be defective in materials or workmanship, after inspection by an authorized American Standard representative, American Standard will repair or, at its option, exchange the product for a similar model. This limited warranty is applicable, so long as it remains in use in its original place of installation, except that the limited warranty applies to a bathing vessel's textured bottom surface only for the first year after the product's initial installation.

This limited warranty applies only to the original purchaser and installation of these products. In the event of a limited warranty claim, proof of purchase will be required—save sales receipt.

This limited warranty does not apply to whirlpool components or to faucets, drains, mounting rims, grab bars or other accessories. If manufactured or supplied by American Standard, such whirlpool components and accessories are covered under separate limited warranties.

This limited warranty does not apply to commercial installations. The warranty for commercial installations is three (3) years.

This limited warranty does not apply to local building code compliance. Since local building codes vary considerably, the purchaser of this product should check with a local building or plumbing contractor to assure local code compliance before installation.

This limited warranty is void if the Americast® brand product has been moved from its initial place of installation; if it has been subjected to faulty maintenance, abuse, misuse, accident or other damage; if it was not installed in accordance with American Standard's instructions; or if it was modified in a manner inconsistent with the product as shipped by American Standard.

American Standard's option to repair or exchange the product under this limited warranty does not cover any labor or other costs of removal or installation. **IN NO EVENT WILL AMERICAN STANDARD BE LIABLE FOR THE COST OF REPAIR OR REPLACEMENT OF ANY INSTALLATION MATERIALS, INCLUDING BUT NOT LIMITED TO, TILES, MARBLE ETC.** American Standard will not be responsible for any other incidental or consequential damages attributable to a product defect or to the repair or exchange of a defective product, all of which are expressly excluded from this limited warranty. This limited warranty does not cover any liability for consequential or incidental damages, all of which are hereby expressly disclaimed, or the extension beyond the duration of this limited warranty of any implied limited warranties, including those of merchantability or fitness for an intended purpose. (Some states or provinces do not allow the exclusion or limitation of implied limited warranties, so this exclusion may not apply to you.)

This limited warranty gives you specific legal rights. You may have other statutory rights that vary from state to state or from province to province, in which case this limited warranty does not affect such statutory rights.

For service under these warranties, it is suggested that a claim be made through the contractor or dealer from or through whom the product was purchased, or that a service request (including a description of the product model and of the defect) be sent to the following address:

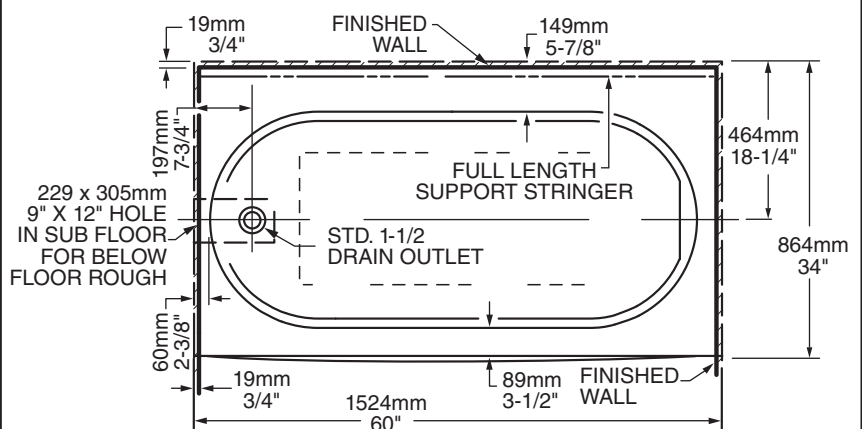

**LEFT HAND TUB ILLUSTRATED RIGHT HAND TUB IS REVERSED**

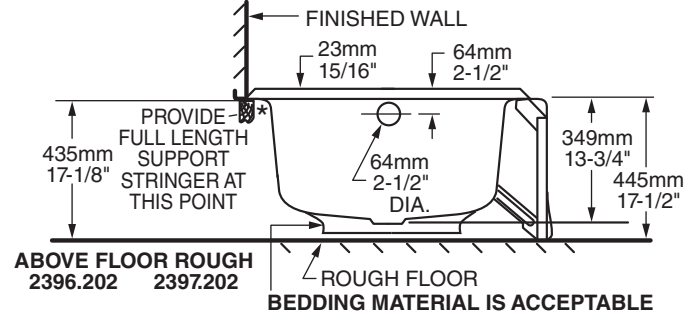
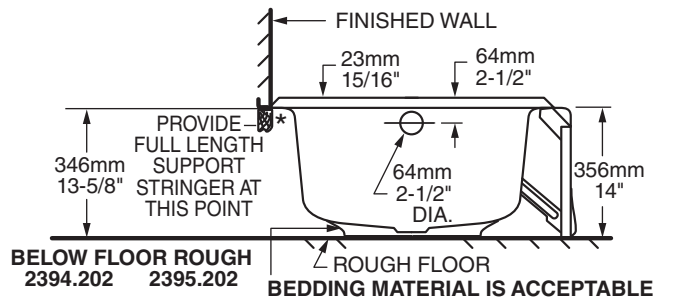

**\* PLUMBER NOTE: PROVIDE FULL LENGTH SUPPORT STRINGER AT THIS POINT**

**In the United States:**  
American Standard Brands  
P.O. Box 6820  
Piscataway, New Jersey 08855  
Attention: Director of Consumer Affairs

For residents of the United States, warranty information may also be obtained by calling the following toll free number: (800) 442-1902  
www.americanstandard.com

**In Canada:**  
AS Canada ULC  
5900 Avebury Rd.  
Mississauga, Ontario  
Canada L5R 3M3

Toll Free: (800) 387-0369  
www.americanstandard.ca

**In Mexico:**  
American Standard B&K Mexico  
S. de R.L. de C.V.  
Via Morelos #330  
Col. Santa Clara  
Ecatepec 55540 Edo. Mexico  
Toll Free: 01-800-839-1200  
www.americanstandard.com.mx