



TARA Profi single-lever mixer - Brushed Chrome







33 880 888 Product version from 5/3/2021



- 7-7/8" Projection
- Swiveling spout 360°
- Aerated stream and spray mode
- Total height 16-3/8"
- 26-1/8" approximate height of Profi spray
- Height to aerator/spout outlet 10-7/8"
- 1-3/8" hole diameter
- 2 x pressure hose with 3/8" compression fitting
- Sprayface with descaling system
- Water flow rate limited to max. 1.5 gpm
- lead-free
- This product can help a building meet the requirements of Green Building Rating Systems, e.g. LEED®, BREEAM®, DGNB

(ADA)

Internal backflow preventer.

	Brushed Chrome	33 880 888-93 0010
	Chrome	33 880 888-00 0010
	Brushed Platinum	33 880 888-06 0010
	Platinum	33 880 888-08 0010
	Dark Chrome	33 880 888-19 0010
	Brushed Bronze	33 880 888-42 0010
	Brushed Dark Platinum	33 880 888-99 0010

Recommended article

AIR SWITCH operating button, trim parts only - Brushed Chrome 10 713 970-93



Recommended article

Soap dispenser with flange - Brushed Chrome 82 444 970-93





TARA Profi single-lever mixer - Brushed Chrome

33 880 888 Product version from 5/3/2021

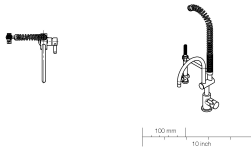
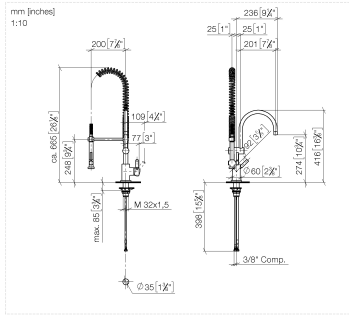

Flow rate chart

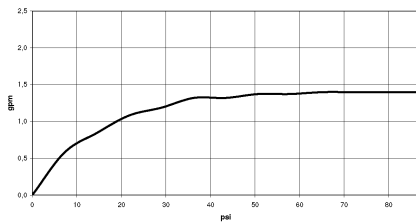

Codes & Standards

ADA	ASME A112.18.1/CSA B125.1	California Energy Commission (CEC)	NSF/ANSI 372
NSF/ANSI/CAN 61	NSF372	NSF61	



TARA Profi single-lever mixer - Brushed Chrome

33 880 888 Product version from 5/3/2021

Certificates

IAPMO_N-4976

IAPMO_6397

TARA Profi single-lever mixer - Brushed Chrome

33 880 888 Product version from 5/3/2021

Parts for other finishes can be found here: [Chrome](#)

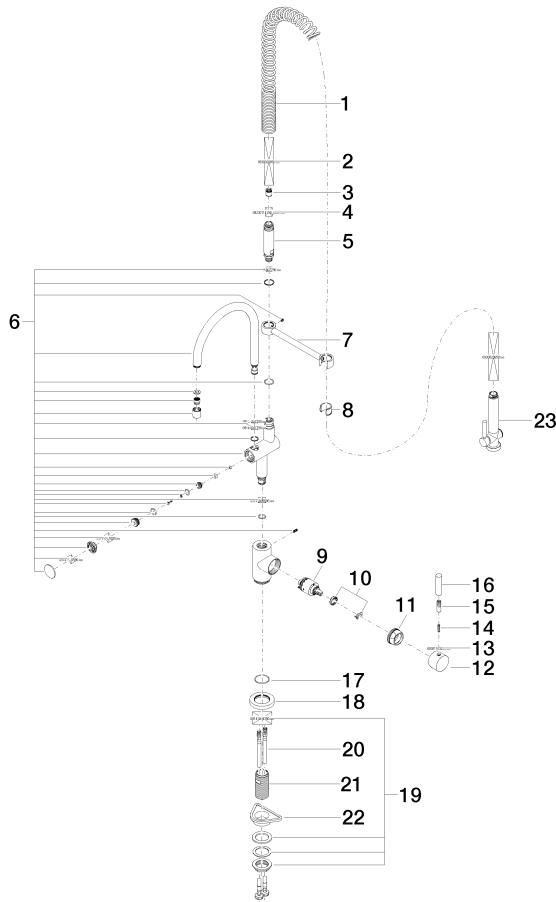



TARA Profi single-lever mixer - Brushed Chrome

33 880 888 Product version from 5/3/2021

Spare parts list

Number	Item Number	Designation	Number of units	Lead time
1	09 16 02 034 90	spring	1	2
2	90 30 02 065 00-93	hose	1	20
3	09 23 01 047 90	back-flow preventer	1	2
4	90 23 01 141 00 90	back-flow preventer	1	2
5	09 30 01 067 10-93	adaptor	1	60
6	90 19 88 019 01-93	spout	1	20
7	04 17 20 014 00-93	holder	1	60
8	90 18 40 035 00 90	sleeve	1	2
9	90 15 05 065 00 90	cartridge	1	2
10	90 28 10 148 00 90	accessories	1	2
11	09 24 04 107-93	nut	1	20
12	90 20 88 040 00-93	handle	1	20
13	90 30 11 032 00 90	disc	1	2
14	09 31 11 010 90	pin	1	2
15	90 24 04 048 00-93	nipple	1	20
16	09 20 62 005-93	handle	1	20
17	09 14 10 102 90	seal	1	2
18	09 28 10 055-93	rosette	1	60
19	04 23 10 009 02 90	fixing set	1	2
20	04 30 04 107 00 90	hose	2	2
21	09 30 01 010 90	adaptor	1	2
22	09 18 40 090 90	sleeve	1	2
23	90 12 11 097 11-93	shower	1	20