

AXOR ShowerSolutions
Showerhead 250 2-Jet Ceiling Connection, 1.75 GPM
 Finishes : Part no. : **35365821**



Features

- Consists of: Showerhead, ceiling connector, Green Diverter
- Shower head size: 250 mm
- Spray modes: PowderRain, Intense PowderRain
- Adjustment with shift on thermostat
- dynamic spray nozzles move out while using
- Flow: 1.75 GPM (6.6 L/Min)
- Showerhead removable for cleaning
- ServiceCard with sieve can be removed without tools for cleaning purpose
- Connection type: basic set

Item details

List Price

Technology



Compliance



Product image



Scale drawing

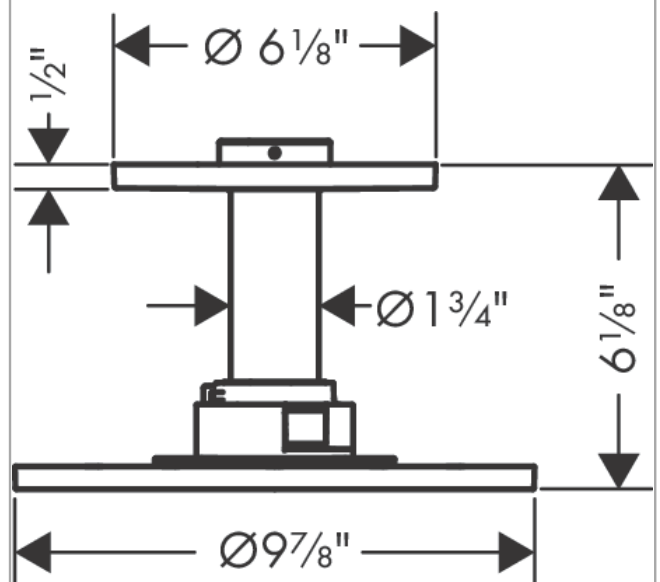

AXOR ShowerSolutions
Showerhead 250 2-Jet Ceiling Connection, 1.75 GPM
Finishes : Part no. : **35365821**



Exploded drawing

Year of production: >07/21

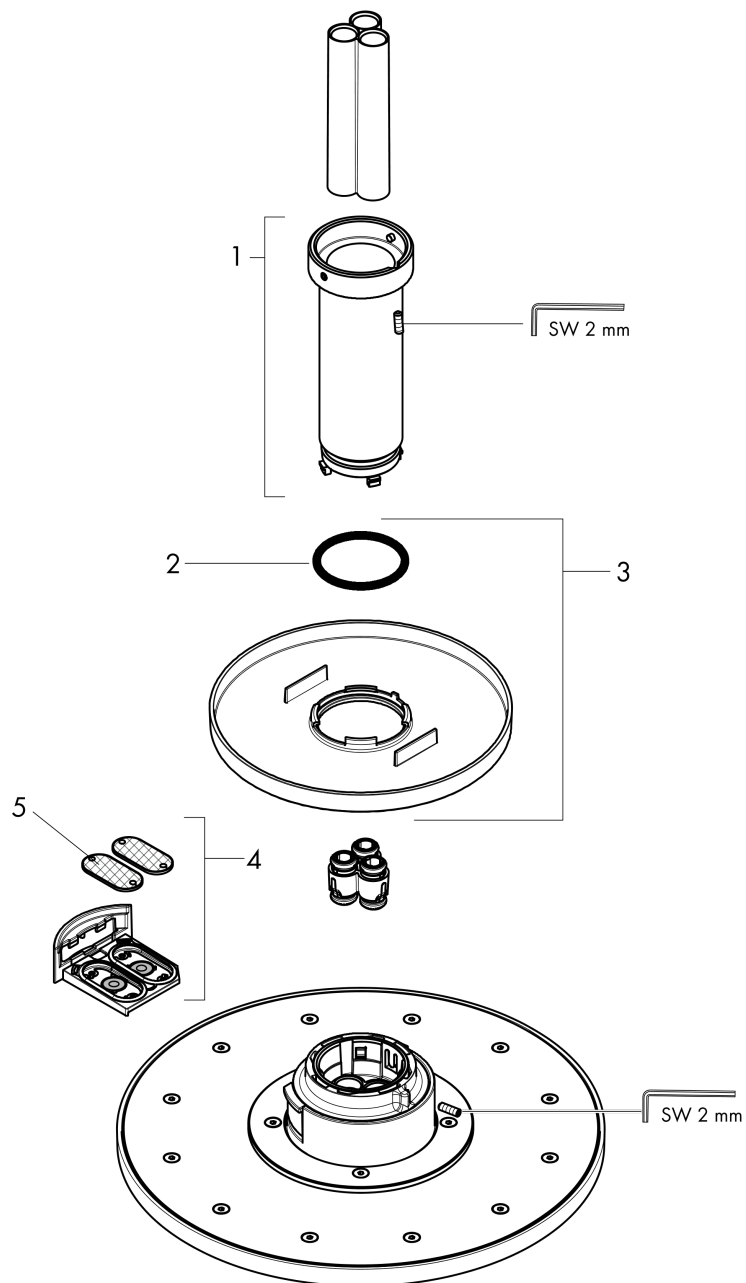

AXOR ShowerSolutions
Showerhead 250 2-Jet Ceiling Connection, 1.75 GPM
 Finishes : Part no. : **35365821**



Spare parts list

Year of production: >07/21

Pos.		Part no.	Price	PU
1	sleeve	92709000	-	1
2	O-ring 42x3,5	92708000	-	1
3	escutcheon	93420820	-	1
4	service unit	94448821	-	1
5	filter	93402000	-	1