



## MEM Wall mounted two-way diverter - Brushed Platinum

36 200 782 Product version from 4/1/2022









- Manual diverter
- Flange 2-3/8" x 2-3/8"
- with integrated shut-off  
**(ADA)**

**Does not allow for simultaneous use of functions**

(ADA)

Does not allow for simultaneous use of functions

	Brushed Platinum	36 200 782-06 0010
	Chrome	36 200 782-00 0010
	Platinum	36 200 782-08 0010
	Dark Chrome	36 200 782-19 0010
	Brushed Durabronze (23kt Gold)	36 200 782-28 0010
	Brushed Dark Platinum	36 200 782-99 0010

### Required article



- Wall mounted two-way diverter -** 35 202 970-90  
0010
- Max. rough in depth "
  - Min. rough in depth "



## MEM Wall mounted two-way diverter - Brushed Platinum

---

36 200 782 Product version from 4/1/2022

mm [inches]

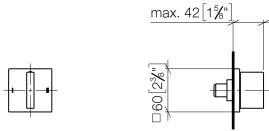

### Flow rate chart

---



### Codes & Standards

---

ASME A112.18.1

California Energy  
Commission  
(CEC)

cUPC



## MEM Wall mounted two-way diverter - Brushed Platinum

---

36 200 782 Product version from 4/1/2022

### Certificates

---

IAPMO\_4976 (

**MEM Wall mounted two-way diverter - Brushed Platinum**

36 200 782 Product version from 4/1/2022

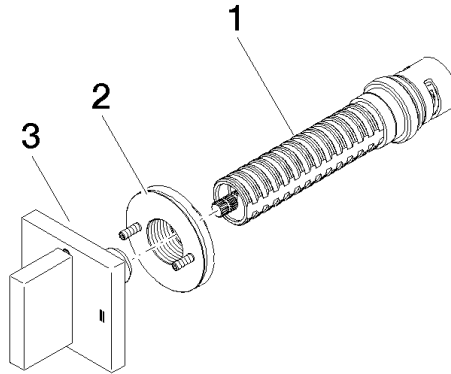

**Spare parts list**

Number	Item Number	Designation	Number of units	Lead time
1	90 90 03 306 10 90	diverter	1	2
2	90 21 02 181 00 90	disc	1	2
3	90 20 78 002 09-06	handle	1	10