

MEM Wall-mounted single-lever mixer without drain - Brushed Platinum

36 861 782



- 8-1/8" Projection
- Rigid spout
- Rectangular aerated stream
- Spout hole diameter 1-1/2"
- Hole diameter single-lever mixer 2-1/4"
- 3-1/8" x 2-3/8" flange for spout
- Flange for mixer 3-1/8" x 3-1/8"
- Water flow rate limited to max. 1.2 gpm
- lead-free
- This product can help a building meet the requirements of Green Building Rating Systems, e.g. LEED®, BREEAM®, DGNB **(ADA)**

(ADA)

	Brushed Platinum	36 861 782-06 0010
	Chrome	36 861 782-00 0010
	Platinum	36 861 782-08 0010
	Dark Chrome	36 861 782-19 0010
	Brushed Durabrass (23kt Gold)	36 861 782-28 0010
	Brushed Champagne (22kt Gold)	36 861 782-46 0010
	Champagne (22kt Gold)	36 861 782-47 0010
	Brushed Dark Platinum	36 861 782-99 0010

Required article



- Rough for wall-mounted faucet -** 35 860 970-90 0010
- Max. rough in depth "
 - Min. rough in depth "
 - Rough can be rotated to position the lever on top or to the left of the spout.



MEM Wall-mounted single-lever mixer without drain - Brushed Platinum

36 861 782

mm [inches]

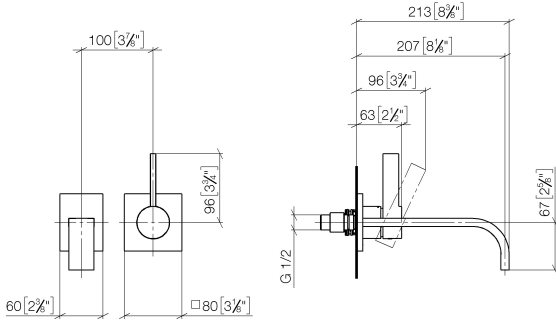

Flow rate chart

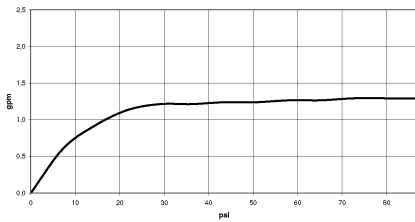

Codes & Standards

ADA	ASME A112.18.1	ASME A112.18.1/CSA B125.1	California Energy Commission (CEC)
cUPC	EPA WaterSense	NSF/ANSI 372	NSF/ANSI/CAN 61
NSF372	NSF61	Water Sense	WaterSense





MEM Wall-mounted single-lever mixer without drain - Brushed Platinum

36 861 782

Certificates

IAPMO_N-4976

IAPMO_6397

IAPMO_8834

IAPMO_4976 (

MEM Wall-mounted single-lever mixer without drain - Brushed Platinum

36 861 782

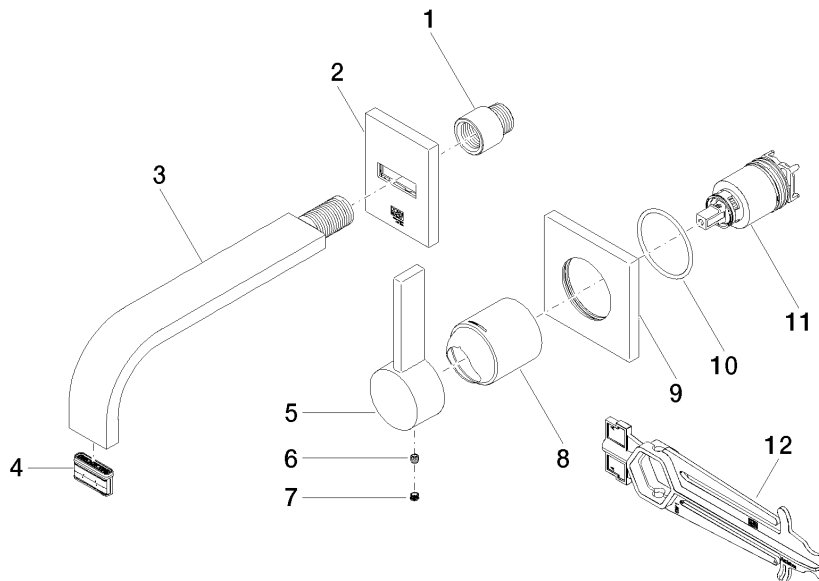

Spare parts list

Number	Item Number	Designation	Number of units	Lead time
1	09 24 03 072 10 90	nipple	1	2
2	90 27 78 055 00-06	rosette	1	10
3	04 28 22 149 10-06	spout	1	10
4	90 29 03 118 00 90	aerator	1	2
5	09 20 78 058-06	handle	1	10
6	90 31 11 030 00 90	pin	1	2
7	90 31 20 109 00 90	plug	1	2
8	09 11 02 288-06	cover	1	10
9	09 27 78 039-06	rosette	1	10
10	90 14 10 049 00 90	seal	1	2
11	90 15 05 064 01 90	cartridge	1	2
12	90 30 09 064 00 90	key	1	2