

AXOR Universal Circular Shelf, 16"

Finishes : Part no. : **42844250**



Features

- Wall-mounted
- Material frame: solid Brass
- Material shelf: Metal
- With mounting material
- Concealed fastening
- Diameter of drilled hole: 6 mm
- Suitable for installation inside shower compartment

Item details

List Price

Product image



Scale drawing

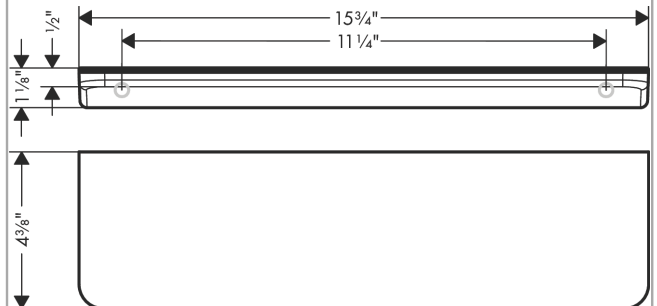

**AXOR Universal Circular
Shelf, 16"**

Finishes : Part no. : **42844250**



Exploded drawing

Year of production: >04/22

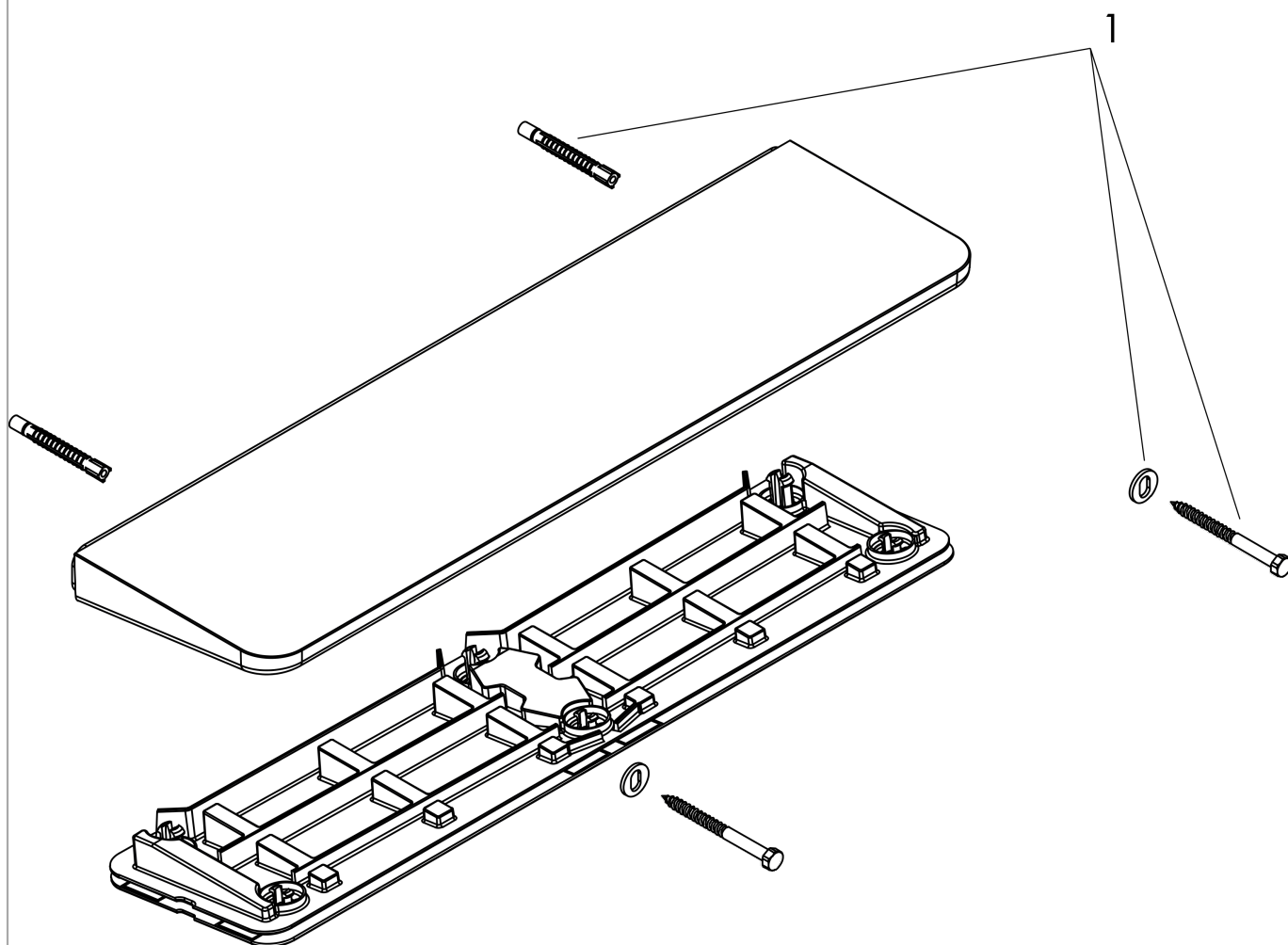

**AXOR Universal Circular
Shelf, 16"**

Finishes : Part no. : **42844250**



Spare parts list

Year of production: >04/22

Pos.		Part no.	Price	PU
1	mounting set	98716000	-	1