

AXOR Universal Circular Shaving Mirror

Finishes : Part no. : **42849340**



Features

- Mirror Glass
- Material frame: Metal
- Arms swivel independently
- With mounting material
- Concealed fastening
- Drilling distance: 51 mm
- Diameter of drilled hole: 6 mm
- Wall-mounted

Item details

List Price

Product image



Scale drawing

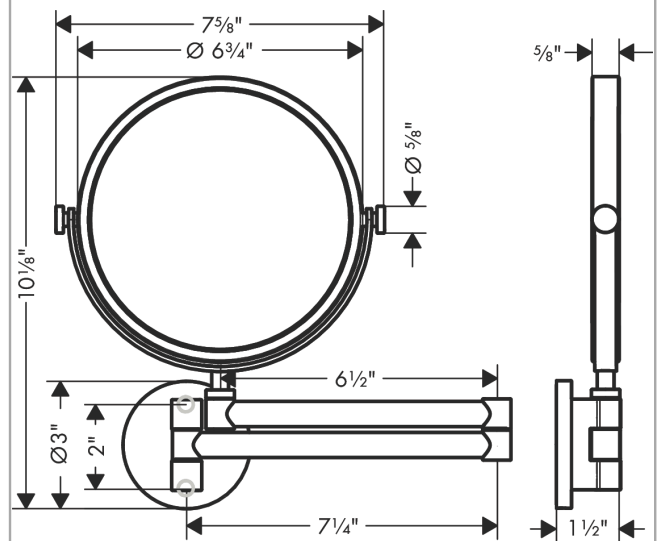

**AXOR Universal Circular
Shaving Mirror**

Finishes : Part no. : 42849340



Exploded drawing

Year of production: >04/22

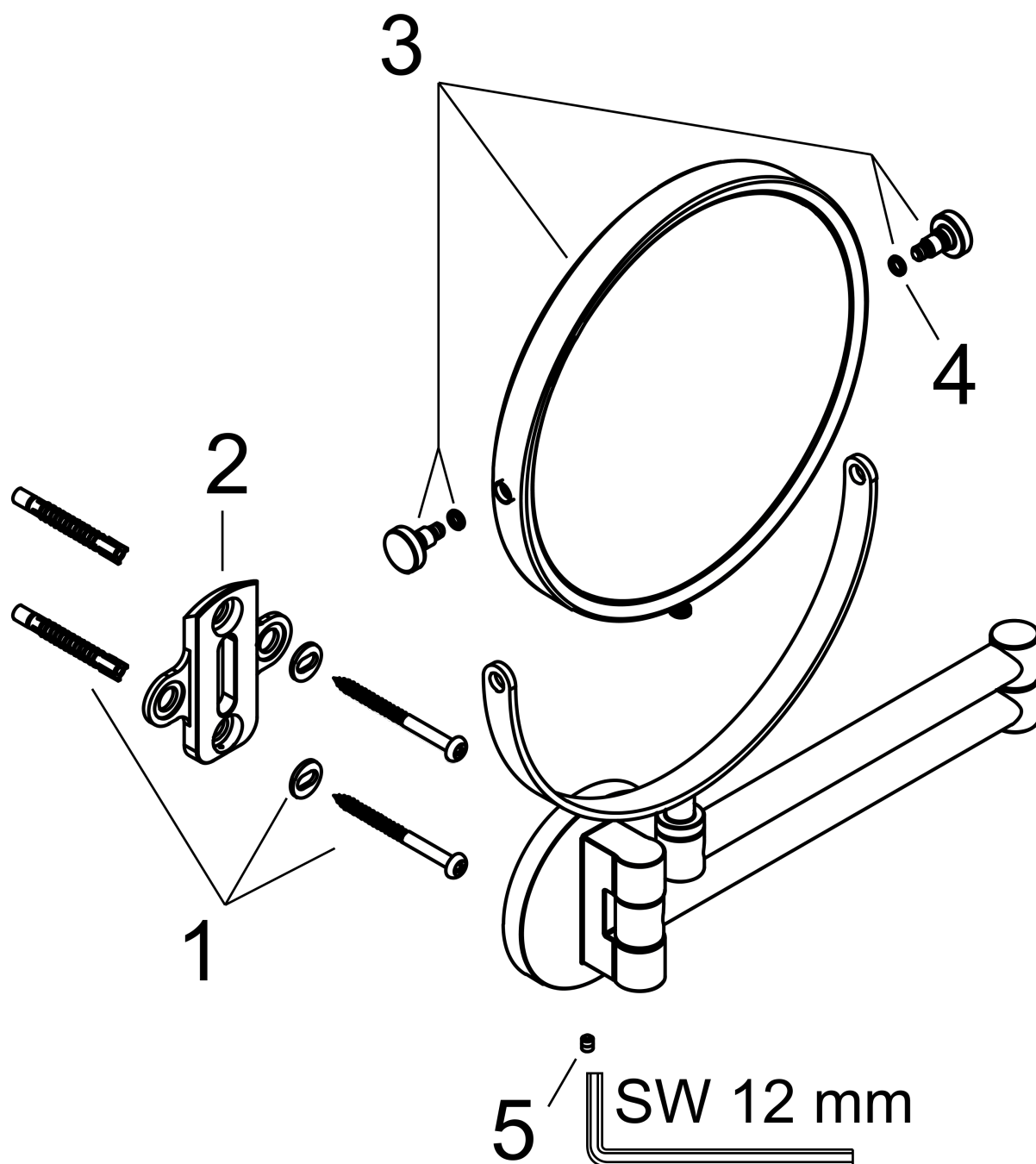

**AXOR Universal Circular
Shaving Mirror**

Finishes : Part no. : **42849340**



Spare parts list

Year of production: >04/22

Pos.		Part no.	Price	PU
1	mounting set	96179000	-	1
2	support element	94430000	-	1
3	mirror	98729340	-	1
4	O-ring 4x1,5	93463000	-	1
5	hollow set screw M4x5	98731000	-	1