



**MODELS**

- 442559 1-3/4 Sink, 9-1/2" bowl depths, WHITE
- 442556 1-3/4 Sink, 9-1/2" bowl depths, ANTHRACITE
- 442557 1-3/4 Sink, 9-1/2" bowl depths, CAFE BROWN
- 442558 1-3/4 Sink, 9-1/2" bowl depths, METALLIC GRAY

**FEATURES**

- Required outside cabinet Drop In installation: 33"
- Required outside cabinet Undermount: 36"
- 80% solid granite
- Heat resistant up to 536°F
- Unsurpassed cleanability backed by industry leading 7 patents!
- Resistant to scratches, stains and all household acids and alkali solutions
- Template provided with approximate 1/8" reveal
- Drop in clips included
- Limited lifetime warranty

**OPTIONAL ACCESSORIES**

Sink Grid: 235914

**CODE/STANDARDS COMPLIANCE**

ANSI Z124.6-97  
IAPMO/UPC listed

**WARRANTY**

BLANCO'S SILGRANIT Series sinks feature a LIMITED LIFETIME WARRANTY to be free of all manufacturing defects under normal use. See our complete warranty for details.

While BLANCO endeavors to provide accurate information, all dimensions are nominal, cannot be guaranteed, and are subject to change or cancellation. BLANCO assumes no responsibility for use of superseded or voided specifications.

**JOB INFORMATION**

Job Name: \_\_\_\_\_

Contact: \_\_\_\_\_

Date Specified: \_\_\_\_\_

Specifier: \_\_\_\_\_

Contractor: \_\_\_\_\_



**NOMINAL DIMENSIONS**

Model 442556 shown

OVERALL	CUT OUT SIZE	SINK DEPTH	DRAIN
33" x 22"	Template provided with approximate 1/8" reveal	9"	3-1/2"

DXF cutout templates available on our website.

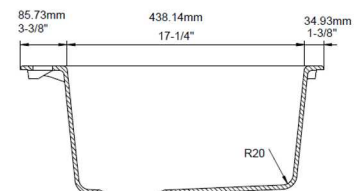
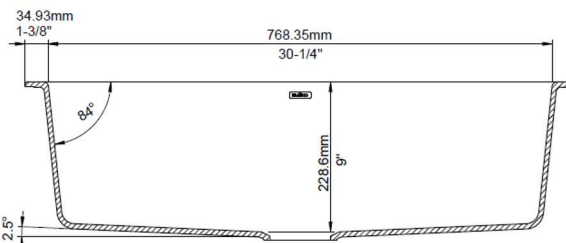
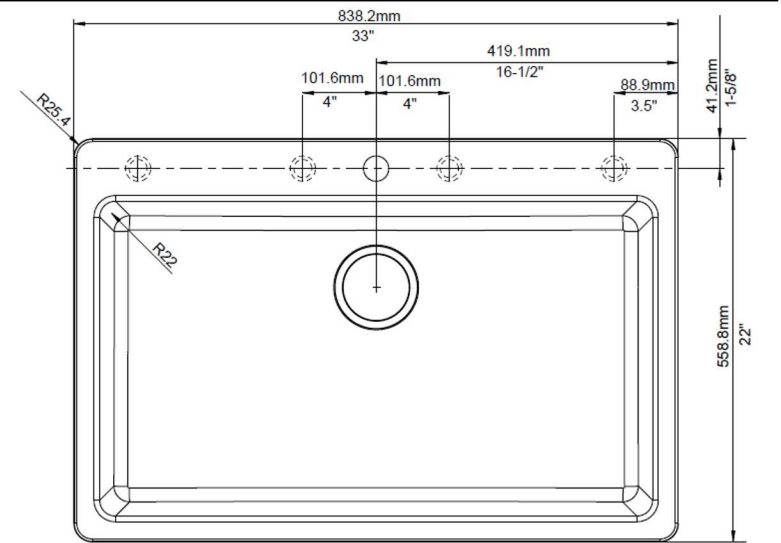

**BLANCO AMERICA**

800.451.5782  
www.blancoamerica.com

© 2018 BLANCO AMERICA

01/18

SPEC-001