

AXOR One
Thermostatic Module Trim for 2 Functions
 Finishes : Part no. : **45712821**



Features

- Thermostatic cartridge, Start/stop cartridge
- Comfortable turning on / off of consumers with large Select-paddle
- Outlets may be operated simultaneously
- Flow: 1.75 GPM (6.6 L/Min)
- Flow rate by simultaneous use of all outlets: 1.75 GPM (6.6 L/Min)
- Anti-scald 100° safety stop
- Trim comes with Select buttons: handshower and Rain
- Finish set, function block

Item details

List Price

Technology



Compliance

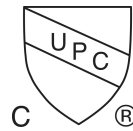

Product image



Scale drawing

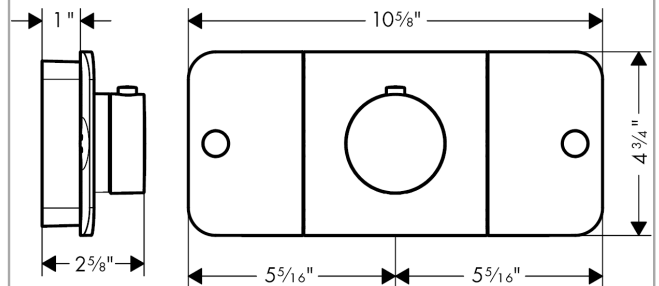

AXOR One
Thermostatic Module Trim for 2 Functions
Finishes : Part no. : **45712821**



Exploded drawing

Year of production: >07/16

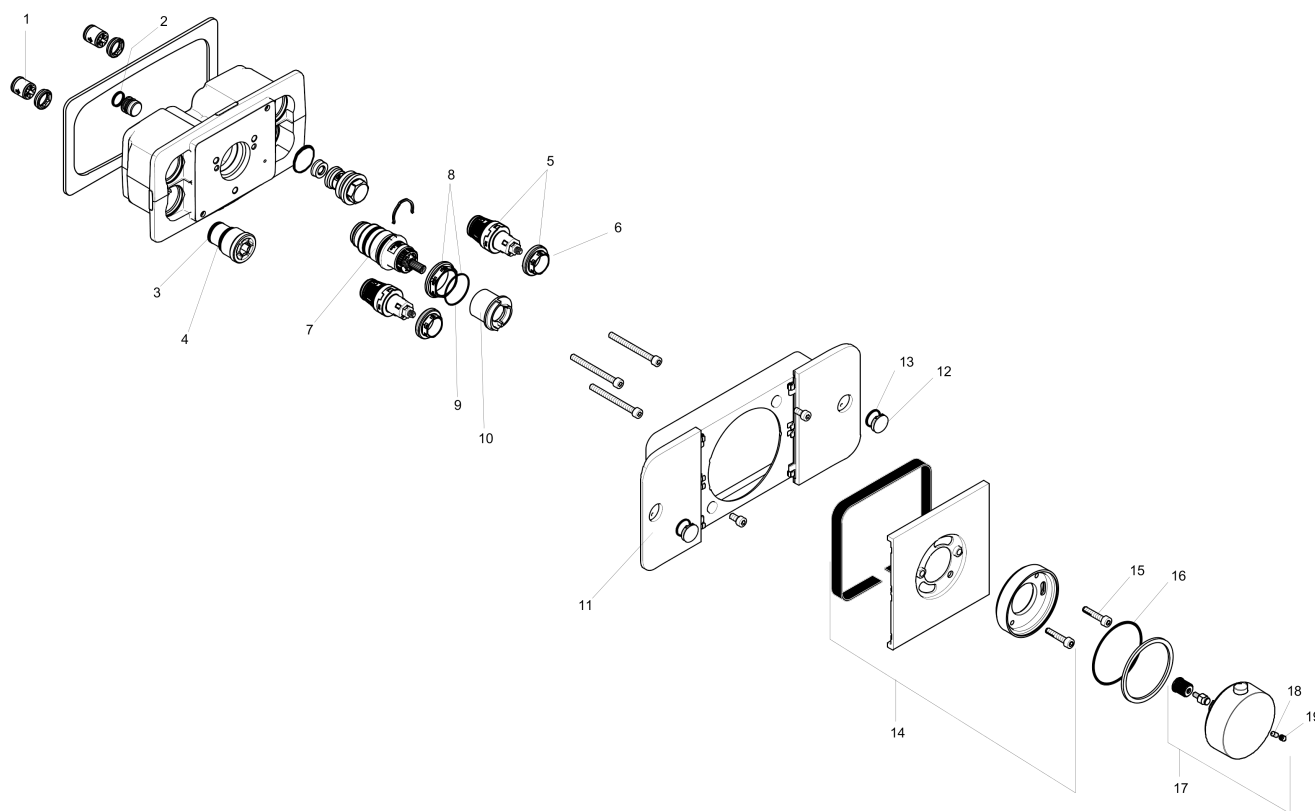

AXOR One
Thermostatic Module Trim for 2 Functions
 Finishes : Part no. : **45712821**



Spare parts list

Year of production: >07/16

Pos.		Part no.	Price	PU
1	non return valve	97980000	-	1
2	O-ring 11x2	98127000	-	1
3	O-ring 17x1,5	98137000	-	1
4	O-ring 21x1,5	98219000	-	1
5	shut off unit	95758000	-	1
6	nut	98368000	-	1
7	thermostat cartridge	98282000	-	1
8	nut	98913000	-	1
9	O-ring 26x1,5	98390000	-	1
10	safety set	92614000	-	1
11	control panel	92612820	-	1
12	set of symbols	92541830	-	1
13	O-ring 13x2	98128000	-	1
14	escutcheon	92599821	-	1
15	hexagon socket screw M5x25	97664000	-	1
16	O-ring 57x2	98210000	-	1
17	handle for thermostat	92600821	-	1
18	hollow set screw M4x8	97669000	-	1
19	screw cover	95181000	-	1