

**AXOR One  
Handshower Holder**

Finishes : Part no. : **45723671**



**Features**

- For Must be used with hose with cylindrical nut
- Metal
- 1/2" NPT

**Item details**

List Price

**Compliance**

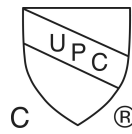

**Product image**



**Scale drawing**

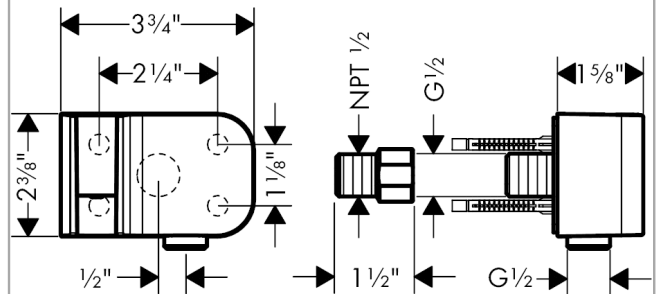

**AXOR One  
Handshower Holder**

Finishes : Part no. : **45723671**



**Exploded drawing**

Year of production: >08/21

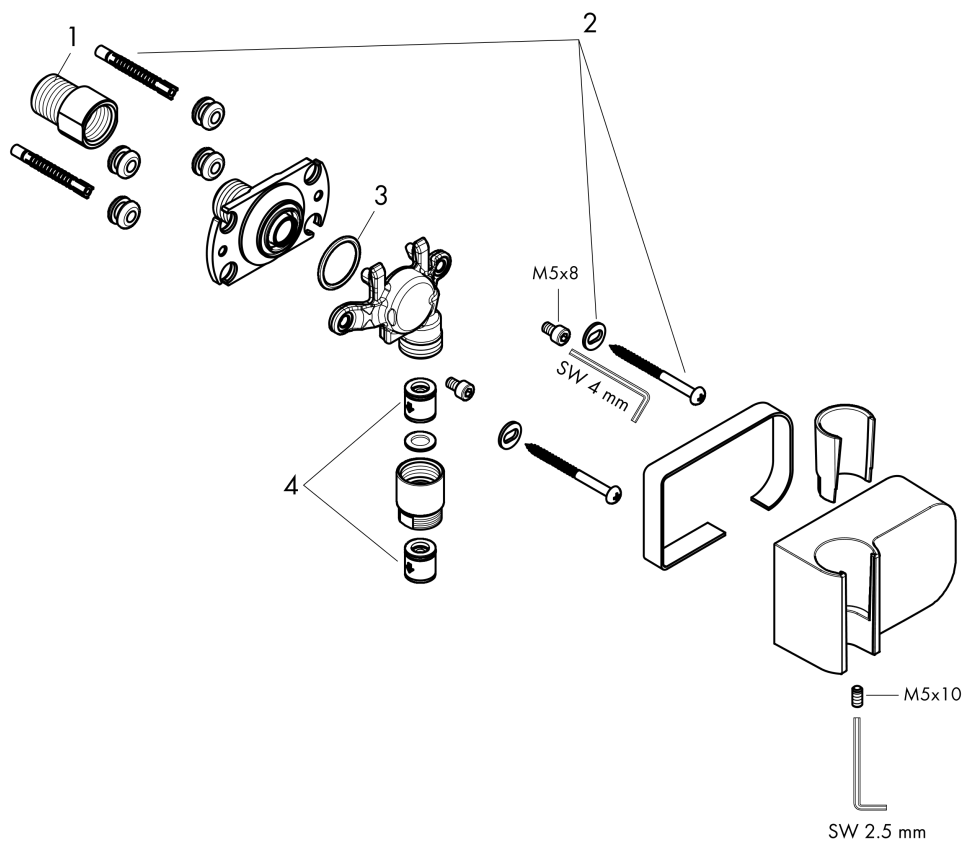

**AXOR One**

**Handshower Holder**

Finishes : Part no. : **45723671**



**Spare parts list**

Year of production: >08/21

Pos.		Part no.	Price	PU
1	adapter for body shower	88746000	-	1
2	mounting set	96179000	-	1
3	O-Ring 22x2	98185000	-	1
4	set of non return valves DW 15	94074000	-	1