

**AXOR One**  
**Single-Hole Faucet 70, 1.2 GPM**  
 Finishes : Part no. : **48001001**



### Features

- Spray modes: Aerated spray
- Flow: 1.2 GPM (4.5 L/Min)
- Ceramic cartridge
- Does not include: Pop-up assembly

### Item details

List Price

### Technology



### Design awards



### Compliance

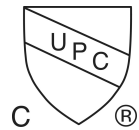

### Product image



### Scale drawing

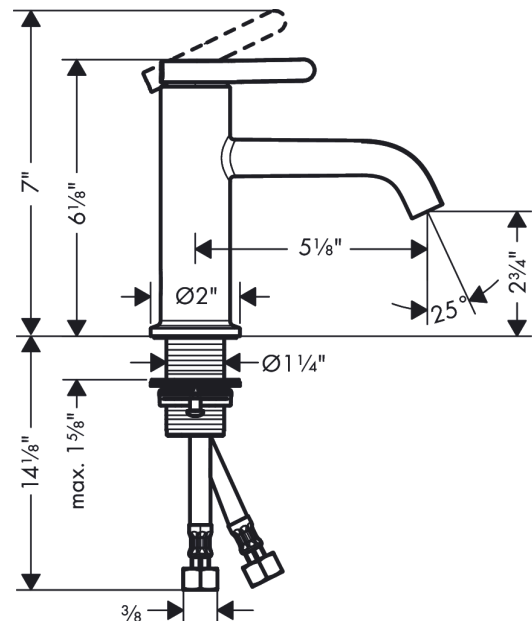

**AXOR One**  
**Single-Hole Faucet 70, 1.2 GPM**  
Finishes : Part no. : **48001001**



## Exploded drawing

Year of production: >08/21

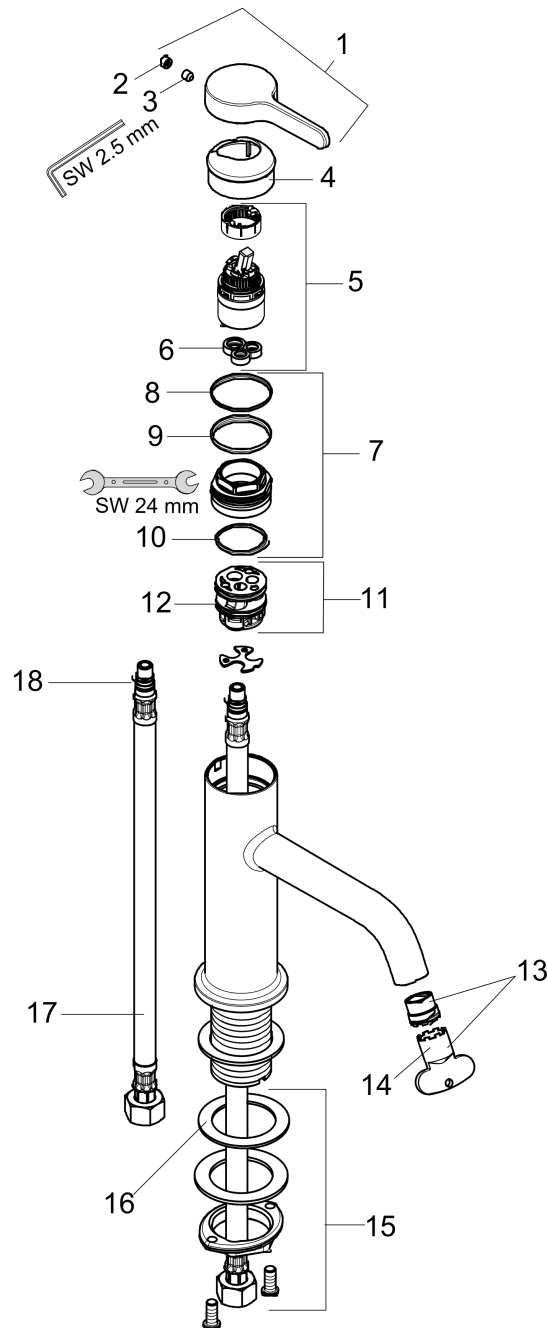

**AXOR One**  
**Single-Hole Faucet 70, 1.2 GPM**  
 Finishes : Part no. : **48001001**



## Spare parts list

Year of production: >08/21

Pos.		Part no.	Price	PU
1	handle	93968000	-	1
2	screw cover	94440460	-	1
3	hollow set screw M5x5	98446000	-	1
4	flange	93737000	-	1
5	cartridge, assy	93760000	-	1
6	seal	93383000	-	1
7	nut	92926000	-	1
8	O-ring 30x1,5	98433000	-	1
9	O-ring 29x2	98391000	-	1
10	O-ring 25x1,5	98146000	-	1
11	adapter for cartridge	98866000	-	1
12	O-ring 23x2	98398000	-	1
13	aerator M16,5x1 (4,5 l/min)	92875000	-	1
14	special tool	98987000	-	1
15	fixing set (Ø 32)	13961000	-	1
16	lever collar	97548000	-	1
17	connection hose 18½" M8x0,75 3/8"	96321001	-	1
18	O-ring 7x1,5	98422000	-	1