

AXOR One
Wall-Mounted Single-Handle Faucet Select, 1.2 GPM
 Finishes : Part no. : **48112001**



Features

- Spray modes: Aerated spray
- Flow: 1.2 GPM (4.5 L/Min)
- Select cartridge for easy, intuitive operation: Push handle to turn water on and off, and turn to adjust temperature
- Does not include: Pop-up assembly

Item details

List Price

Technology



Design awards



Compliance

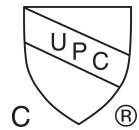

Product image



Scale drawing

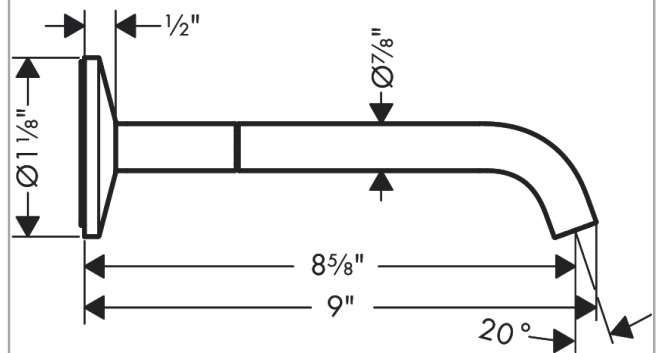

AXOR One
Wall-Mounted Single-Handle Faucet Select, 1.2 GPM
 Finishes : Part no. : **48112001**



Exploded drawing

Year of production: >10/21

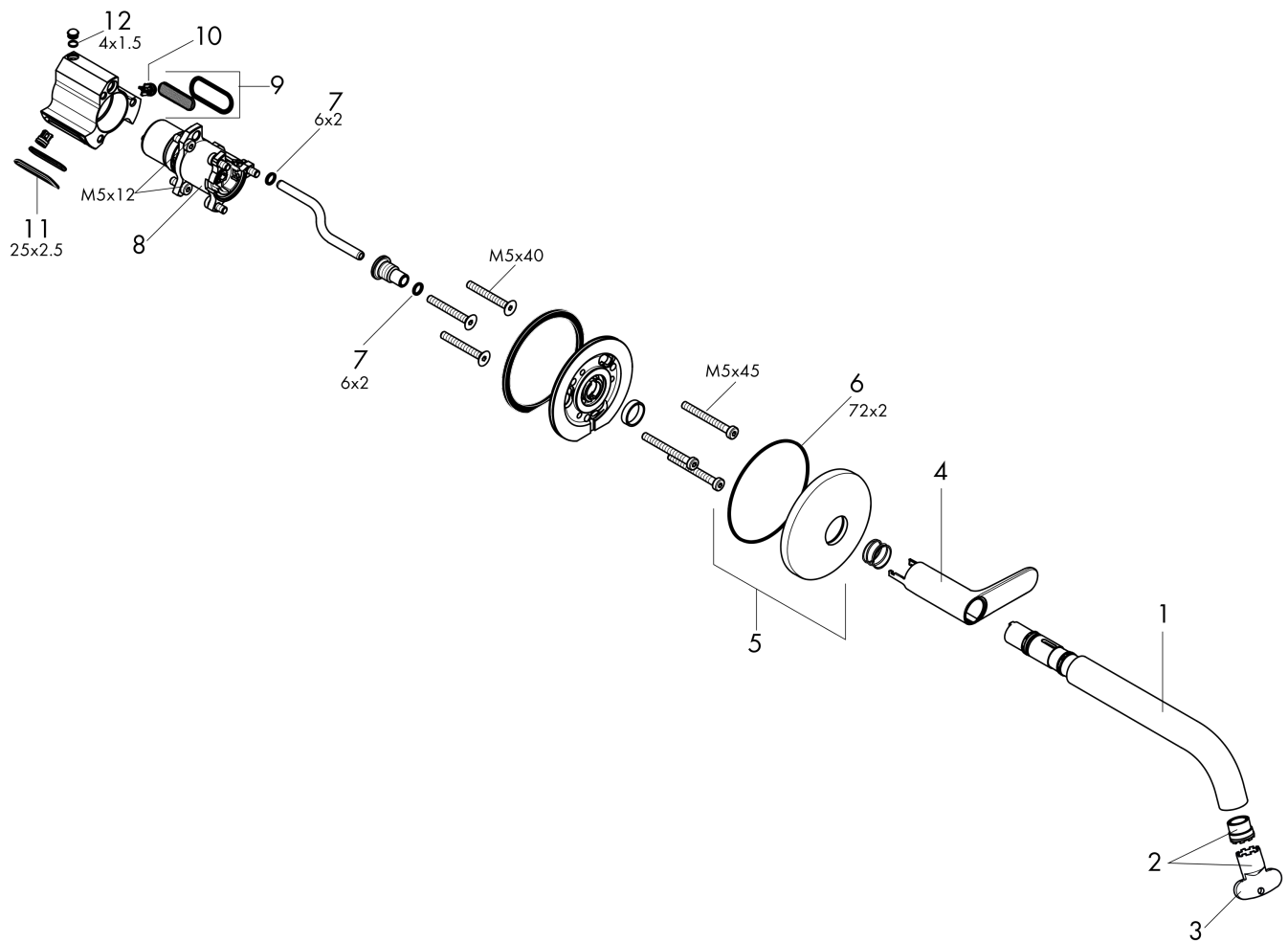

AXOR One
Wall-Mounted Single-Handle Faucet Select, 1.2 GPM
 Finishes : Part no. : **48112001**



Spare parts list

Year of production: >10/21

Pos.		Part no.	Price	PU
1	spout cpl.	94313000	-	1
2	aerator M16,5x1 (4,5 l/min)	92875000	-	1
3	special tool	98987000	-	1
4	handle	94314000	-	1
5	escutcheon Ø 80 mm	94315000	-	1
6	O-ring 72x2	98395000	-	1
7	O-ring 6x2	98458000	-	1
8	cartridge, assy	94317000	-	1
9	filter	94316000	-	1
10	non return valve	93250000	-	1
11	O-ring 25x2,5	92146000	-	1
12	O-ring 4x1,5	93463000	-	1
a	escutcheon Ø 80 mm	13611000	-	1
b	escutcheon height = 36 mm (when wall is not deep enough).	13610000	-	1
c	extension 25 mm	13609000	-	1