

Tecturis S
Single-Hole Fine 240, 1.2 GPM
 Finish: **Chrome** Part no. : **73372001**



Description

Features

- Spout height: 9 Inch
- Handle design: lever handle
- Spray pattern: Aerated spray
- Maximum flow rate (at 3 bar): 4.5 l/min
- Ceramic cartridge

Item details

List Price \$ 470.00

Technology



Design awards



Compliance / Sustainability



Product image



Scale drawing

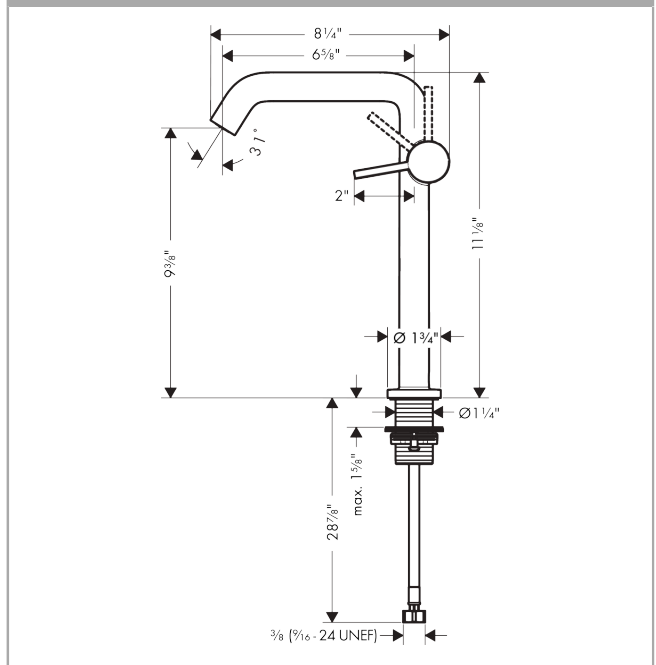

Tecturis S
Single-Hole Fine 240, 1.2 GPM
 Finish: **Chrome** Part no. : **73372001**



Exploded drawing

Year of production: >02/24

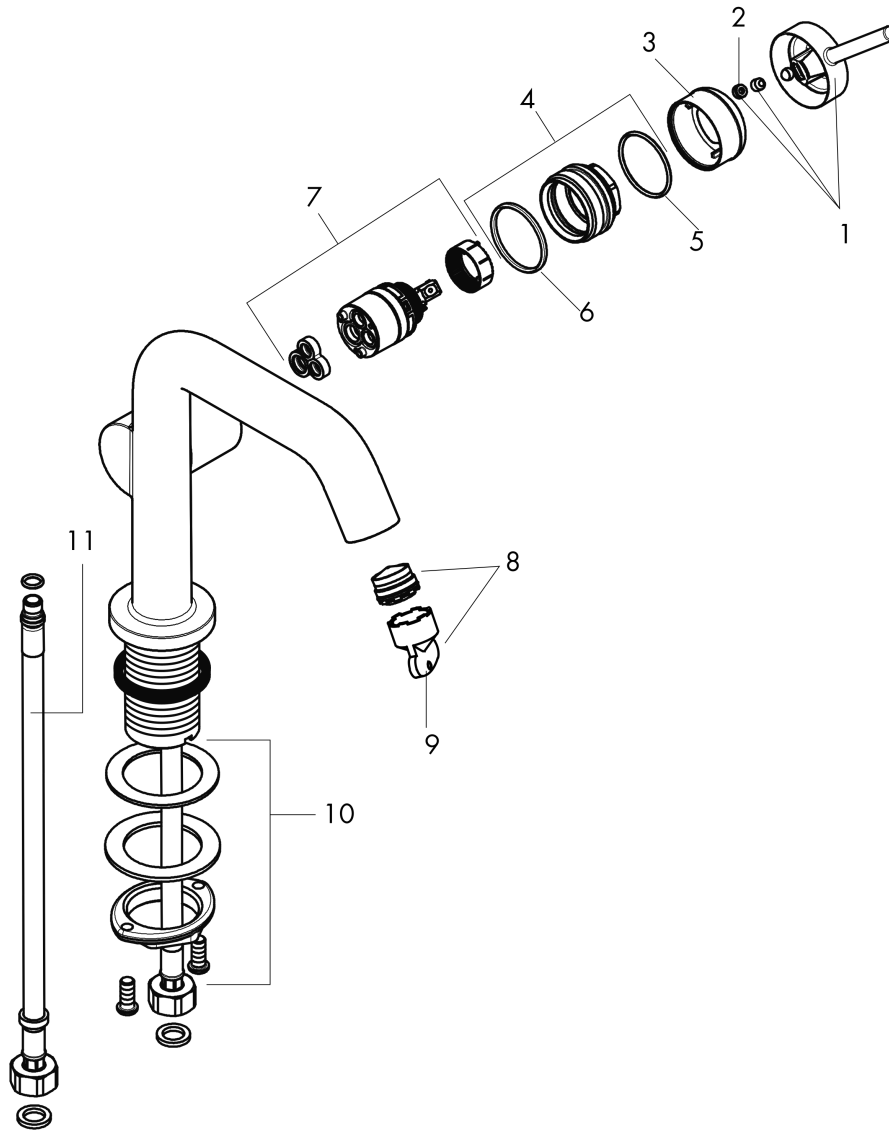

Tecturis S
Single-Hole Fine 240, 1.2 GPM
 Finish: **Chrome** Part no. : **73372001**



Spare parts list

Year of production: >02/24

Pos.	Description	Part no.	Price	PU
1	handle	94999000	-	1
2	screw cover	93735460	-	1
3	escutcheon	94987000	-	1
4	nut	94989000	-	1
5	O-ring 28x1,5	98421000	-	1
6	O-ring 29x2	98391000	-	1
7	cartridge, assy	93760000	-	1
8	aerator cpl.	87100000	-	1
9	service tool	93750000	-	1
10	fixing set (Ø 32)	13961000	-	1
11	connection hose 35½" M8x0,75 3/8"	96316001	-	1