

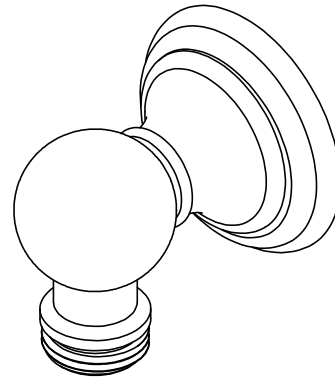

Features

- Over 30 finishes including 14 PVD finishes
- Solid brass construction
- 1/2" NPT (female) inlet connection
- 1/2" NPSM (male) outlet connection

SH-10-42



Codes/Standards Applicable

Meets or exceeds the following at date of manufacture:

- ASME A112.18.1/CSA B125.1

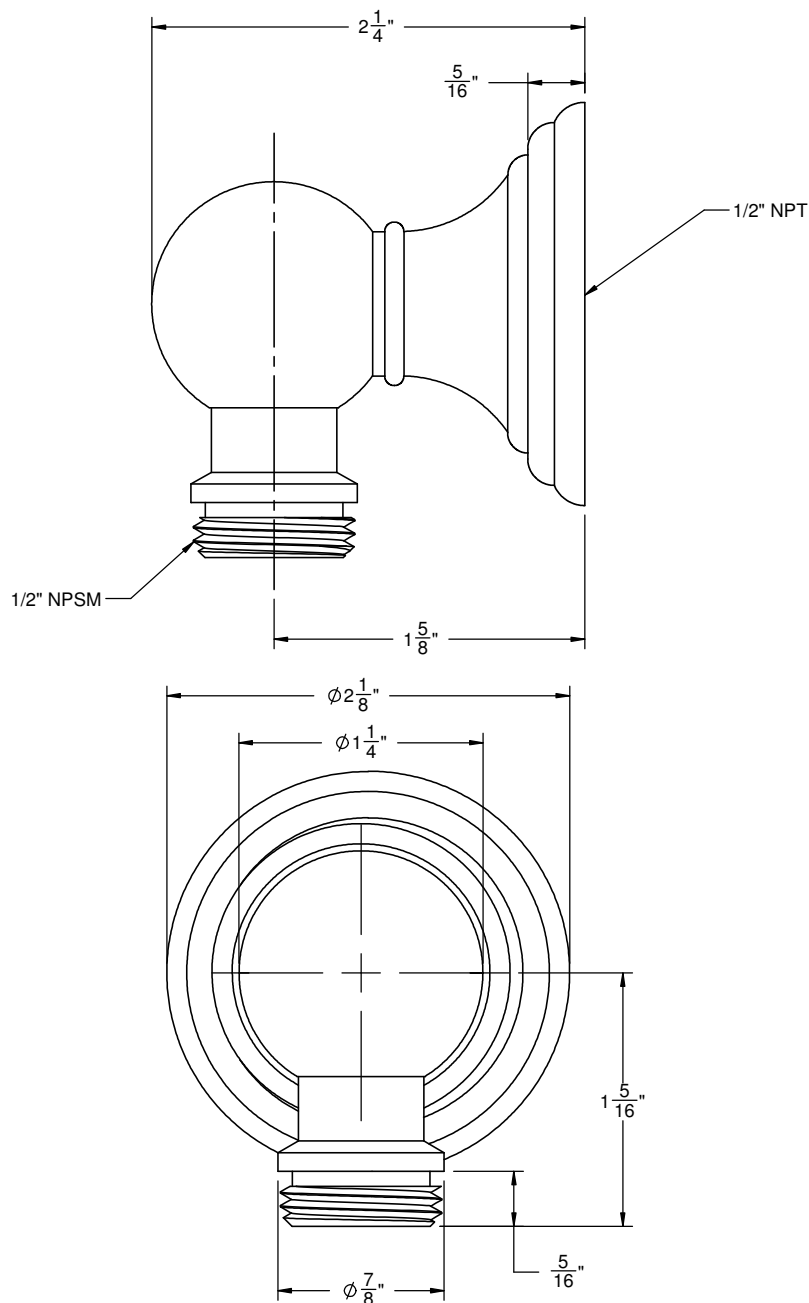

ALL DIMENSIONS SHOWN TO NEAREST 1/16"



Features

- Over 30 finishes including 14 PVD finishes
- Solid brass construction
- All mounting hardware included
- Accepts most conical handshower hoses

SH-20-42

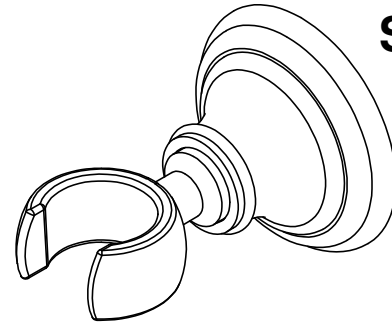

Codes/Standards Applicable

Meets or exceeds the following at date of manufacture:

- ASME A112.18.1/CSA B125.1

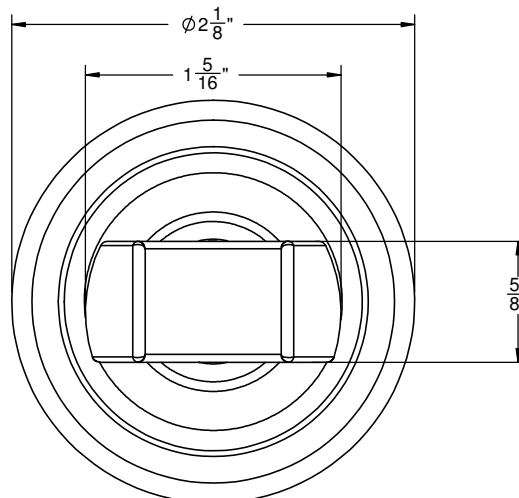
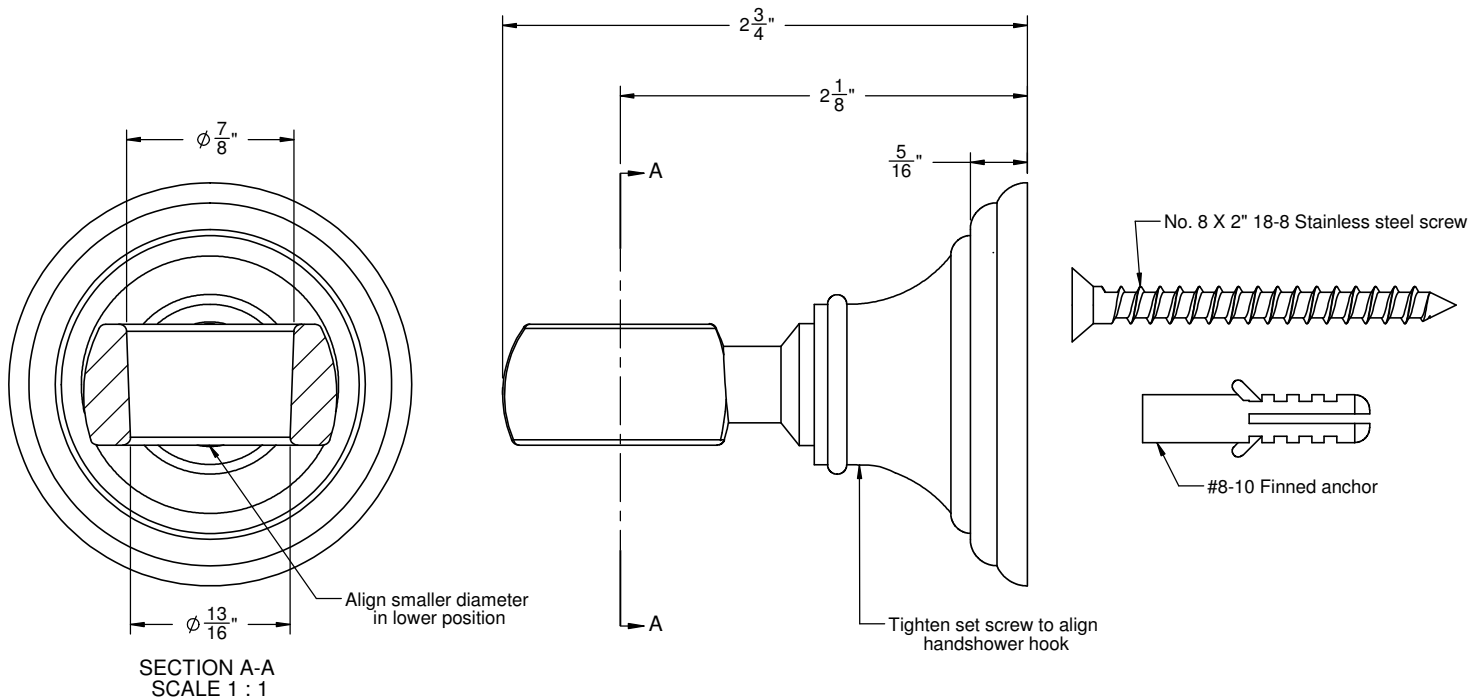

ALL DIMENSIONS SHOWN TO NEAREST 1/16"



California Faucets®

Handshower

HANDSHOWER HOSE

Features

- 1/2" FIP inlet
- 1/2" FIP outlet
- Double spiral out hose for added strength
- Solid brass construction
- Over 30 finishes include 16 PVD finishes

Codes/Standards Applicable

Meets or exceeds the following at date of manufacture:

- ASME A112.18.1/CSA B125.1

HS-68

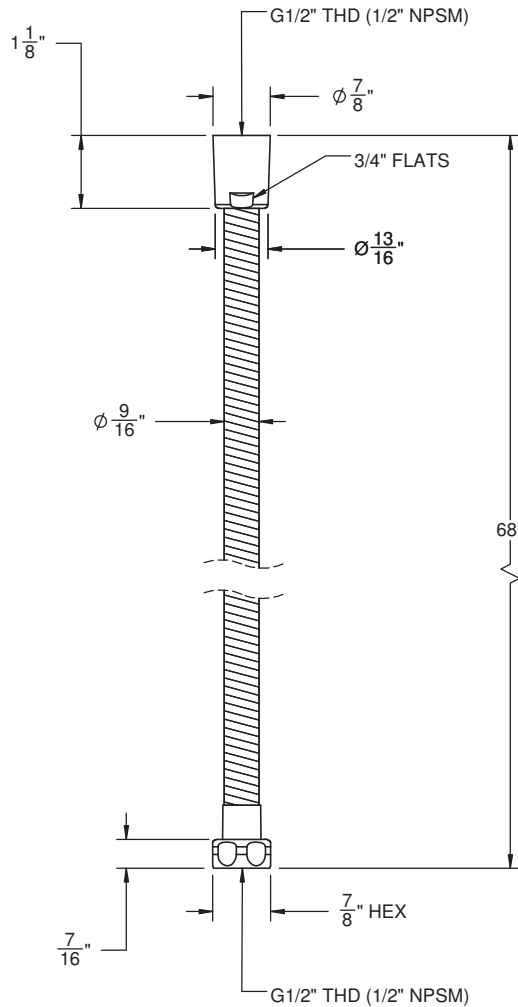

ALL DIMENSIONS SHOWN TO NEAREST 1/16"