

Installation Instructions

# ATTENTION

## **READ THESE INSTRUCTIONS BEFORE INSTALLATION AND USE OF ALL FAUCETS AND WALL VALVES**

### **INSTALLATION and WARRANTY INSTRUCTIONS TECHNICAL INFORMATION**

All flexible hoses are designed and manufactured for use with water in exposed locations only. **Do not expose** to household cleaners, chlorine, chloride, hydrochloric acid or other corrosive chemicals.

- All connections with threads M10x1 male must be hand tighten. **Do not over tighten. Over tightening may cause damage to the hose.**

All faucets washers and o-rings are designed and manufactured for use with water. **Do not expose** to household cleaners, chlorine, chloride, hydrochloric acid or other corrosive chemicals.

Faucets are designed for use with the temperatures and pressures listed below:

- minimum cold water supply 50 °F
- maximum hot water supply 145 °F
- minimum pressure 15 psi
- maximum pressure 75 psi
- maximum fixing torque value = 10 lbf.ft.
- 

**Please note:** The recommended best pressure for best performance is between 40 psi and 60 psi. More pressure than 60 psi or less pressure than 40 psi may affect the diverting action in side spray faucets.

- Do not use any Rohl Country/ Nicolazzi faucet with sulphorous water.
- The minimum temperature for all faucets is 50 degrees F. Below 50 degrees F will void the warranty.
- When available, filter systems must be placed between hot and cold supply lines and the faucet. Improper use or non-use of filters may make diverting faucets with hand sprays perform poorly.
- Don't modify faucet and their components
- Use only original spare parts if there are replacements to be ordered.
- Installation must be made by authorized plumbers or installers. Improper installation or diagnosis of problems is not covered by the warranty.
- Yearly maintenance of cleaning and flushing is recommended.

**Operation and use of any faucet or wall valve that do not conform to these technical instructions will void the warranty.**

## Installation Instructions

### A- INSTRUCTIONS FOR SERVICING THE C7108N HAND SPRAY

- B- Please note: If the hand spray is dripping constantly when using the faucet, the hand spray can be serviced by either stretching the spring or replacing the cartridge. A small drip after use that stops is sometimes normal, as there is a small space between the black aerator and the stop mechanism that holds a ½ teaspoon of water. A drip or two after use is normal.

#### C- To stretch the spring:

- a. Unscrew ring c7108/7
- b. Remove c7108/8 black faceplate- Push the button or remove with tool
- c. Stretch the spring c7597 slightly
- d. Reassemble and test

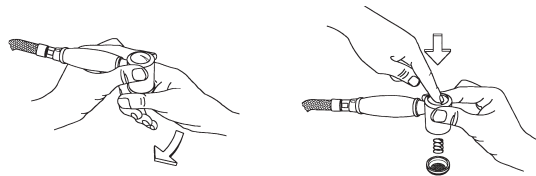

#### D- To change the cartridge in the hand spray c7108kit

- a. Unscrew the spray head- 2
- b. Unscrew the faceplate ring
- c. Push the button in to eject the cartridge from the head.
- d. Remove the decorative button from the old assembly
- e. Put on the new assembly
- f. Insert in the metal head
- g. Install the spring, aerator and ring
- h. Install back on the handle
- i. Test the unit for leaks

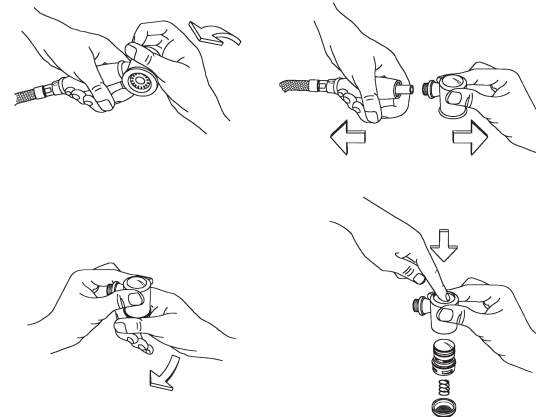

## Installation Instructions

- E- Clean or replace the back flow preventer c7076**
- a. Disconnect the flexible hose from the spray head
  - b. Remove the spray head from the handle-2
  - c. Remove the nylon insert-3+4
  - d. Remove the back flow preventer- not shown
    - i. Refer to exploded drawing
  - e. Replace or clean the check valve
  - f. Insert new or serviced check valve back into the handle
    - i. Note: make sure the flow restrictor is not backwards
  - g. Reverse steps and test.

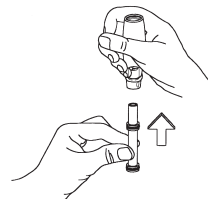
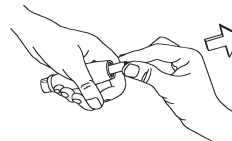
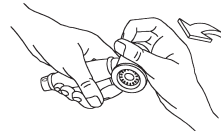
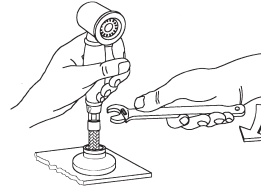

## Installation Instructions

### Spare Parts

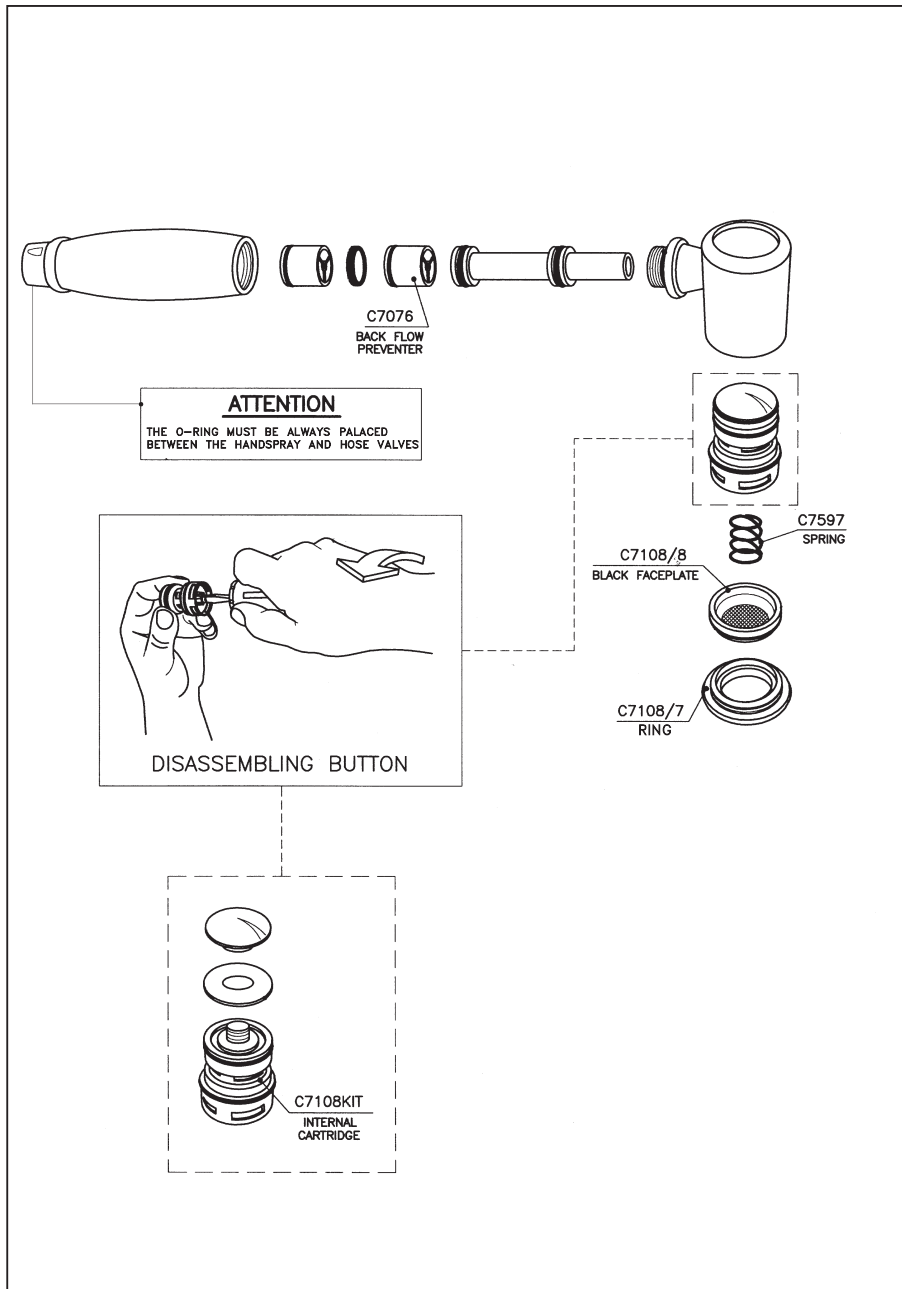

Consult your local ROHL showroom for additional information and specifications. For complete warranty details and a list of showrooms, go to [www.rohlhome.com](http://www.rohlhome.com).

## Installation Instructions

### LOW FLOW OR NO FLOW TROUBLESHOOTING INSTRUCTIONS (ALL MODELS: A3608 shown)

Current kitchen faucets have a flow rate of 1.5 GPM from the aerator and the hand spray.

If you are experiencing low flow from the spout: Do not change the cartridge

- Unscrew and clean the aerator 1
- Unscrew and clean the filters inside the supply connections. 3
- Check the supply lines for kinks or obstructions. 3
- Make sure the supply line stops are fully on. Not shown

If your faucet has a hand spray, and your hand spray has obstructed flow or no flow:

- Check the hand spray hose for kinks. 5
- Unscrew and clean the hand spray filter. 4
- Clean the aerator in the hand spray. 2

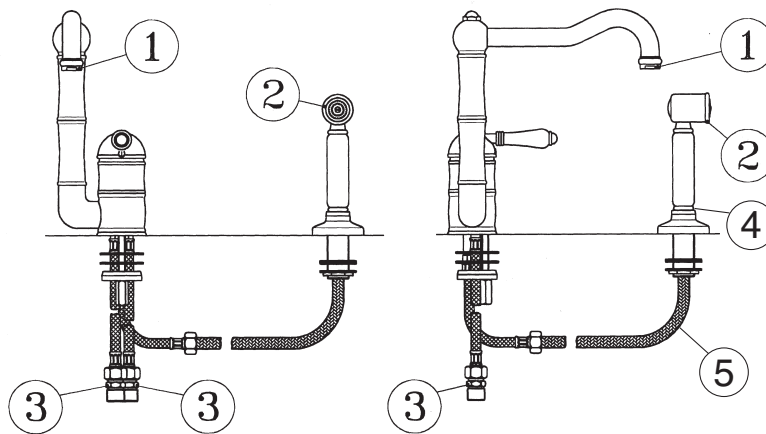

## Installation Instructions

### Care and use for finishes

Country Bath Products are all authentic finishes that have not been coated with any product.

After each use, pat the fixture down to remove any excess water. This will prevent any water spotting or mineral build-up. Use only soft liquid soap and water to clean the surface. Use a soft brush to clean any gaps. Avoid any products that have ammonia or alcohol like Windex, 409 or Fantastik. These products can damage the finish leaving black or white spots. Never use an abrasive product like Softscrub, Comet, Ajax or Bon Ami.

For deep polishing we recommend Bruno's Wax for all finishings.

Tuscan Brass is a living finish and has no warranty. It will lighten with use. To extend the life of the finish, apply Bruno's Wax by patting it on, letting it dry and patting it off. Never rub or buff this finish.

**WARNING:** the use of cleaning products not recommended might irreparably harm the surfaces of the faucets which in such case are not covered by our warranty.

### Limescale

The faucet is fitted with an aeration device in the Hot/Cold water outlet.

This may need occasional cleaning especially in hard water areas.

This is accomplished by unscrewing the outlet in a counter clockwise direction, dismantling and leaving the inner screen mesh immersed over night in vinegar or lemon juice.

Do not use chemical descaling liquids for this purpose.