

# 56" PAN ACRYLIC FREESTANDING TUB

Cat. No.

ATOVN56BIG



L: 55-1/2"  
W: 29"  
H: 22"

Water Depth: 16-5/8" to top of tub  
Water Depth: 13-1/4" to overflow  
Overflow slot: 3" under tub rim

The following is recommended for  
ATOVN56BIG tubs:

- Faucets: part #4602, 4022 and 4025
- Freestanding Supplies: #4502

Gallon Capacity with OF: 45  
Shipping Weight: 124 lbs.  
Empty Weight: 75 lbs.  
Filled Weight with OF: 449 lbs.

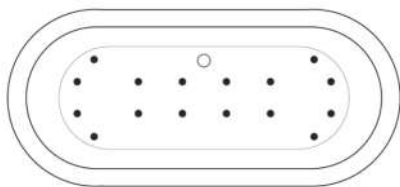

(Air jet configuration if system is added,  
more info on page 2.)

## Features:

- ▶ Acrylic construction for lighter weight
- ▶ No faucet holes
- ▶ Overflow slot with integrated drain
- ▶ Drain and overflow covers included (available in 7 finishes)
- ▶ For use with a freestanding tub filler or faucet mounted on the bathroom wall
- ▶ Option to add foam insulation between tub walls available
- ▶ Tap Deck
- ▶ **New:** Air Jet system available, more info on page 2

## Finishes:

<b>CP</b>	Polished Chrome	<b>PB</b>	Polished Brass
<b>BN</b>	Brushed Nickel	<b>PN</b>	Polished Nickel
<b>ORB</b>	Oil Rubbed Bronze	<b>MB</b>	Matte Black
<b>WT</b>	White		



**Custom Colors Available** (inside of tub is always white enamel):  
Painted bathtubs are considered "special order" and are not returnable  
\$160 Bisque or Black \$250 Designer Color

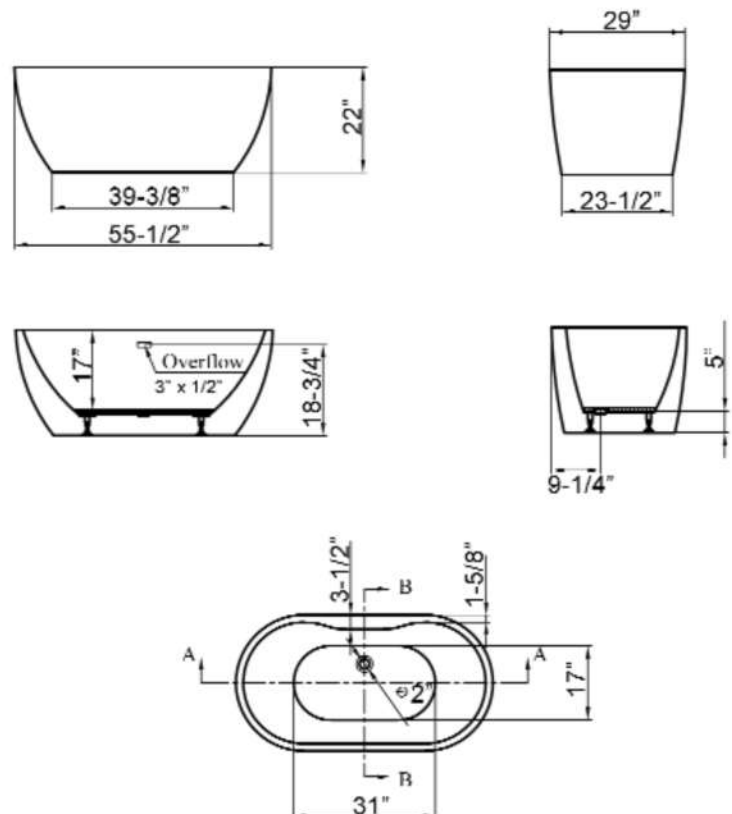

Dimensions of fixture are nominal and specifications subject to change without notice.



# BATHTUB AIR JET KIT

Cat. No.  
AIR KIT 1, AIR KIT 2

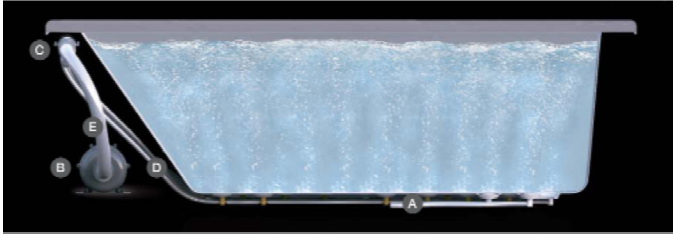

- A** AIR JET - Bottom air jets for maximum bubble action.
- B** BLOWER - The heart of the massage system.
- C** MANIFOLD - Double back flow security prevention device.
- D** FLEXIBLE PVC HOISING - IAPMO certified.
- E** MAIN AIR INTAKE HOSE - High temperature and pressure resistant.

## Features:

- ▶ 750 Watt blower motor operates system
- ▶ 300 Watt air heater warms air
- ▶ System powered by 120V
- ▶ 16 brass air jets placed in bottom of tub
- ▶ Each air jet has 24 holes
- ▶ Air jet caps available in white (AIR KIT 1) or black (AIR KIT 2)
- ▶ Includes 1 1/4" x 3' main air hose plus 1 1/4" x 9' extension hose
- ▶ Automatic system purge after each use
- ▶ Automatic safety timer turns off system after 20 minutes
- ▶ Includes water tight remote control
- ▶ Compatible with most acrylic, copper and resin tubs with no feet
- ▶ Not available with cast iron tubs or tubs with feet

**Air Kit is installed in tub before shipment**

## INSIDE TUB VIEW - WILL VARY BY TUB DESIGN



Air Jet



Remote

**Oval bathtub**  
Sample jet configuration

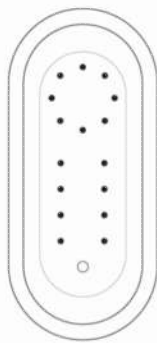

with end drain

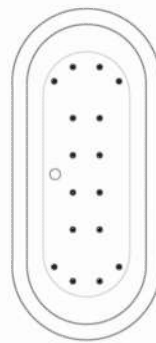

with center drain

**Rectangular bathtub**  
Sample jet configuration

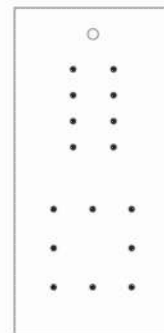

with end drain

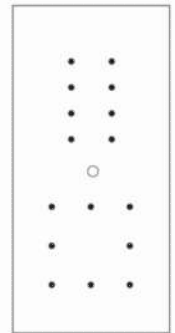

with center drain

**Round bathtub**  
Sample jet configuration

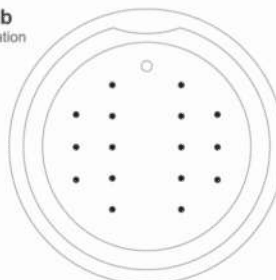

These diagrams are general representations.  
Jet placement may vary dependent on tub shape

### Features:

(16) Maxi Air Jets



Elbows for air jets



Tees for air jets