

61" PENNEY ACRYLIC OVAL TUB

Cat. No.
ATOVN61FIG



Faucet not included

L: 60-3/4"
W: 29-3/8"
H: 22-1/4"

Water depth: 16-3/4" to top of tub
Water depth: 14" to overflow
Overflow slot: 3" under tub rim

The following is recommended for ATOVN61F tubs:

- Faucets:part #4602, 4022 or 4025
- Rigid, freestanding supplies:part #4502

Gallon Capacity with OF: 35
Shipping Weight: 134 lbs.
Empty Weight: 70 lbs.
Filled Weight with OF: 363 lbs.

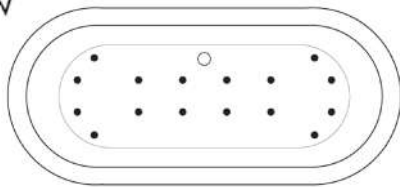

(Air jet configuration if system is added, more info on page 2.)

Features:

- ▶ Acrylic construction for lighter weight
- ▶ Air between sheets to provide insulation to help retain warmth
- ▶ Overflow slot with integrated drain
- ▶ No faucet holes
- ▶ No tap deck
- ▶ Angle slope of tub: 36°
- ▶ Drain and overflow covers included (available in 7 finishes)
- ▶ Option to add foam insulation between tub walls available
- ▶ For use with a freestanding tub filler or faucet mounted on the bathroom wall
- ▶ **New:** Air jet system now available, more info on page 2

Finishes:

- CP** Polished Chrome
- BN** Brushed Nickel
- ORB** Oil Rubbed Bronze
- WT** White
- PB** Polished Brass
- PN** Polished Nickel
- MB** Matte Black



Custom Colors Available (inside of tub is always white enamel):
Painted bathtubs are considered "special order" and are not returnable
\$160 Bisque or Black \$250 Designer Color

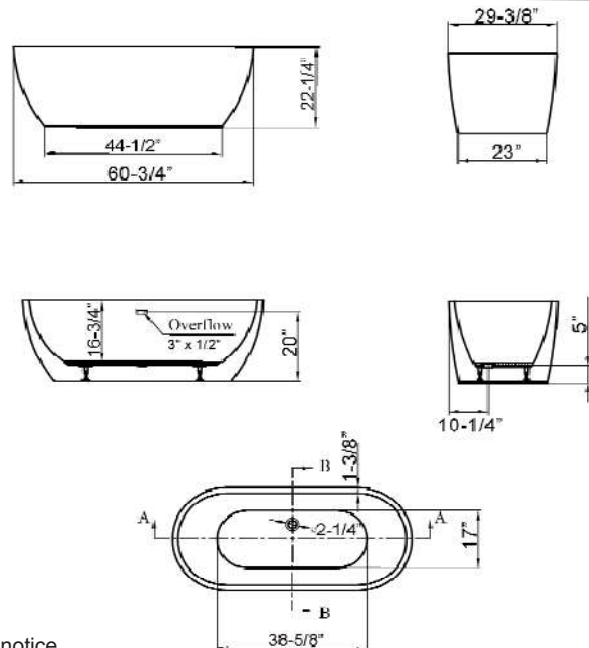

Dimensions of fixture are nominal and specifications subject to change without notice.

BATHTUB AIR JET KIT

Cat. No.
AIR KIT 1, AIR KIT 2



- A** AIR JET - Bottom air jets for maximum bubble action.
- B** BLOWER - The heart of the massage system.
- C** MANIFOLD - Double back flow security prevention device.
- D** FLEXIBLE PVC HOISING - IAPMO certified.
- E** MAIN AIR INTAKE HOSE - High temperature and pressure resistant.

Features:

- ▶ 750 Watt blower motor operates system
- ▶ 300 Watt air heater warms air
- ▶ System powered by 120V
- ▶ 16 brass air jets placed in bottom of tub
- ▶ Each air jet has 24 holes
- ▶ Air jet caps available in white (AIR KIT 1) or black (AIR KIT 2)
- ▶ Includes 1 1/4" x 3' main air hose plus 1 1/4" x 9' extension hose
- ▶ Automatic system purge after each use
- ▶ Automatic safety timer turns off system after 20 minutes
- ▶ Includes water tight remote control
- ▶ Compatible with most acrylic, copper and resin tubs with no feet
- ▶ Not available with cast iron tubs or tubs with feet

Air Kit is installed in tub before shipment

INSIDE TUB VIEW - WILL VARY BY TUB DESIGN



Air Jet



Remote

Oval bathtub
Sample jet configuration

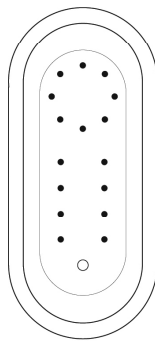

with end drain

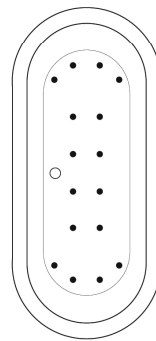

with center drain

Rectangular bathtub
Sample jet configuration

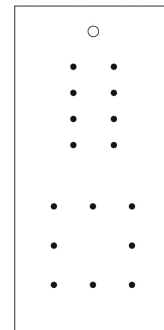

with end drain

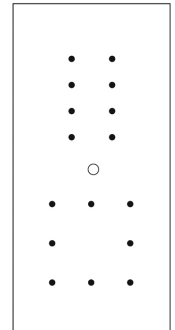

with center drain

Round bathtub
Sample jet configuration

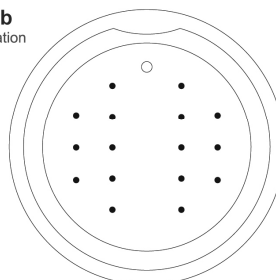

These diagrams are general representations.
Jet placement may vary dependent on tub shape

Features:

(16) Maxi Air Jets



Elbows for air jets



Tees for air jets