

Please go to www.quoise.com for product cleaning tips. Go to the **Care + Maintenance** selection.

Tools Required: Flathead screwdriver, Phillips screwdriver, pliers, wire cutters, wire strippers, electrical tape, safety glasses.

Light Source: (5) A19 Medium Base Bulbs 100W Maximum.

Estimated Assembly Time: 30-45 minutes

Preparation: Identify and inspect all parts before beginning installation. Check package content list and diagrams below to be sure all parts are present. If any parts are missing or damaged, do not attempt to assemble, install, or operate the fixture. Contact customer service for replacement parts.

⚠ Warnings and Cautions

Turn off electricity at circuit breaker or main fuse box before installation. Consult a licensed electrician if in doubt.

These instructions are provided for your safety. It is very important you read them completely before installing the fixture. We strongly recommend that a licensed, professional electrician perform the installation.

Disconnect fixture from power source before replacing bulbs. Make sure bulbs are given sufficient time to cool before removal.

Package Contents

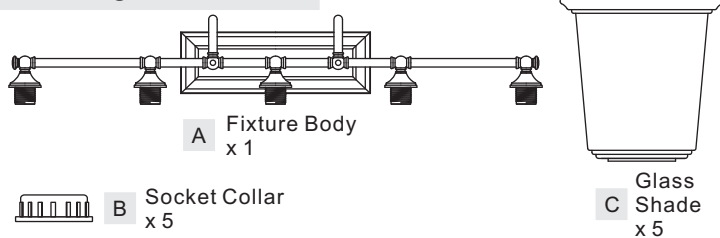

Hardware Contents

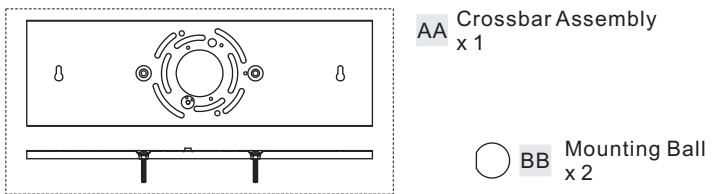

STEP 1 - Installing the Crossbar Assembly

A. Pass the supply wires through the Crossbar Assembly (AA). Attach the Crossbar Assembly (AA) to the Outlet Box with the head of the Green Ground Screw facing you. Secure the Crossbar Assembly (AA) with Outlet Box Screws (not included). Tighten until snug.

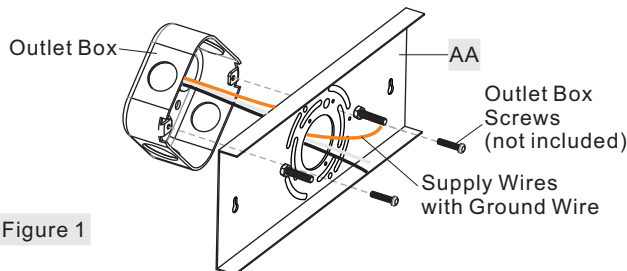

STEP 2 - Wire Connections

A. Use standard wire connectors (not included) to make all wire connections. Twist connectors until wires are tightly joined together. Wrap each connection with approved electrical tape and carefully stuff all the connected wires into the Outlet Box.

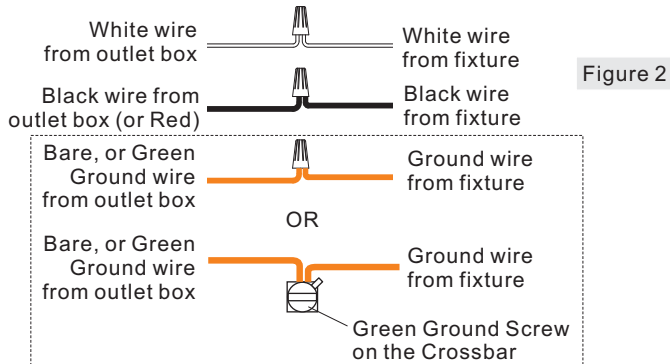

STEP 3 - Install the Fixture Body

A. Position the backplate and Fixture Body (A) onto the mounting screws and Crossbar Assembly (AA). Secure the backplate and Fixture Body (A) by using the Mounting Balls (BB) and hand tighten the Mounting Balls (BB) until snug.

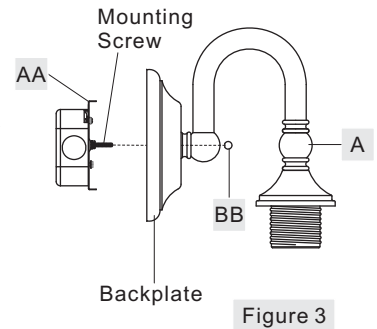

STEP 4 - Install Shades and Bulbs

A. Place the Glass Shade (C) over the socket and secure with the Socket Collar (B). Hand tighten until snug.
B. Insert the bulb onto socket and screw snugly into place.

Your fixture is now assembled and ready to use. Enjoy!

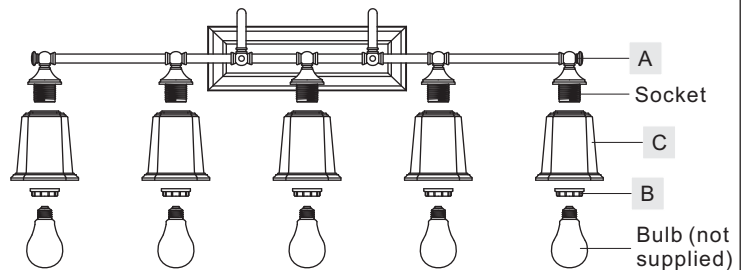

Thank you for purchasing a Quoizel product.
Need assistance with parts or assembly? Call Quoizel customer service at 1-800-645-3184
or visit us on-line at www.quoise.com

NL8605C

FINISH: POLISHED CHROME

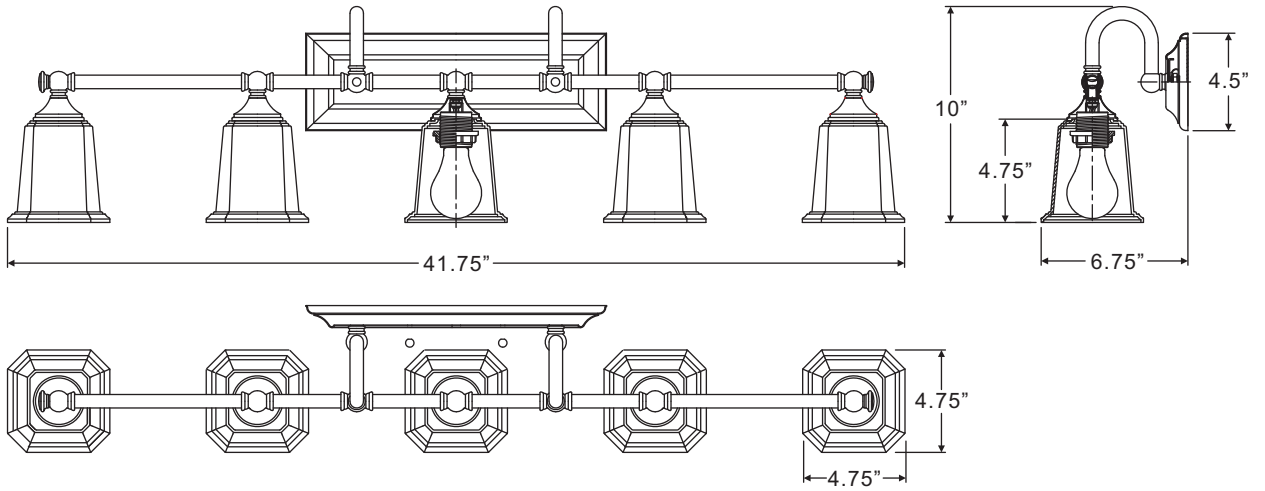
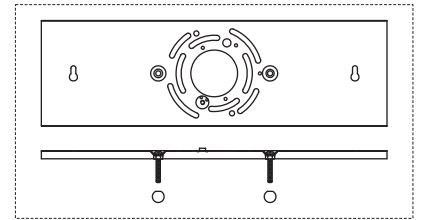

NOTE: ALL DIMENSIONS ARE ROUNDED UP TO THE NEAREST 1/4"

Thank you for purchasing a Quoizel product.
Need assistance with parts or assembly? Call Quoizel customer service at 1-800-645-3184
or visit us on-line at www.quoise.com