

Elinor 60 x 32 AcrylX Freestanding Bathtub

Model number:

106426-000-002-100

Dimensions: 60" x 32" x 23"

Installation: Freestanding

Material: AcrylX™ Applied Acrylic



Standard Features:

- Sleek and comfortable 2-piece freestanding bathtub
- Inclined backrest and deep bathing well
- Ample deck space for faucet installation
- End drain
- Above-the-Floor Rough (AFR) and F2 Drain compatible
- MAAX innovative leveling legs for easy installation

Product characteristics:

- Made in North America
- 1 Tub - 2 Pieces
- Deck Space for Faucet

Standard Colors:



White (002)

Certifications

MAAX products adhere to one or more of the following certifications:



MAAX

Elinor 60 x 32 AcrylX Freestanding Bathtub

Model number:

106426-000-002-100

Dimensions: 60" x 32" x 23"

Installation: Freestanding

Material: AcrylX™ Applied Acrylic

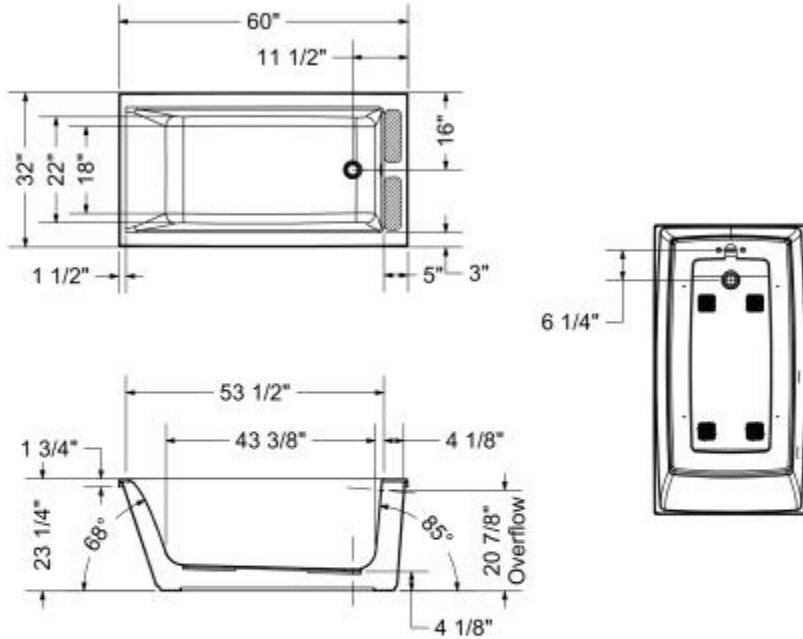

() : Recommended faucet area 2 sections of 12" (L) x 3 1/2" (W).

All dimensions are approximate. Structure measurements must be verified against the unit to ensure a proper fit.

Dimensions

60 x 32 x 23 In.
(1524 x 813 x 584 mm)

Water Capacity

65 gallons - 245 liters

Weight

100 lbs - 45 1/4 kg

Bathing Well

43 1/4 In. x 24 In.
(1095 mm x 610 mm)

Deep Sump Height

19.125 In. - 486 mm

Deck Width

2.75 In. - 70 mm

Drain location:

End

Project:

Contractor:

Representative:

Date:

Tel:

Notes:

MAAX