

B3Round 4834 Acrylic Configurable Shower Base

Model number:

410002-506-001-000

Dimensions: 47.875" x 33.875" x 4"

Installation:

Material: Acrylic

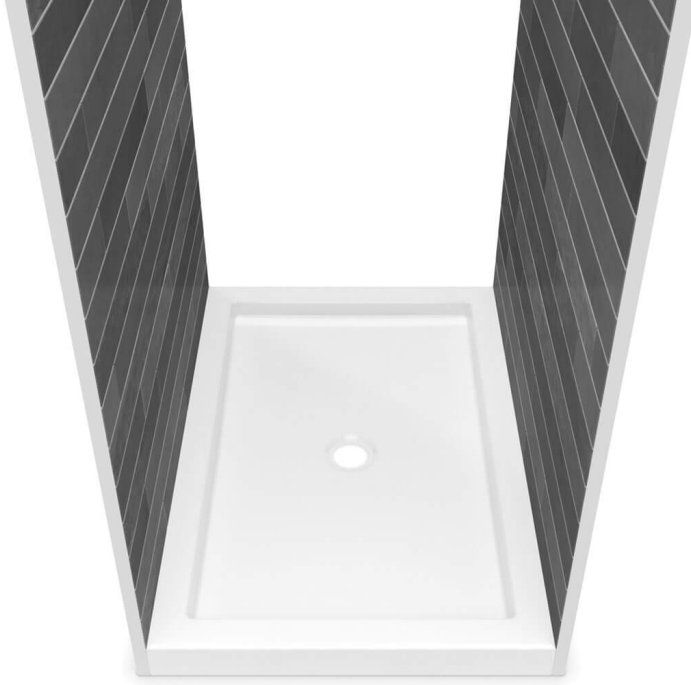

Standard Features:

- Acrylic rectangular shower base with round drain
- Smooth floor
- Center drain
- Certain configurations available with Stabili-T anti-slip bottom meeting ADA, ANSI or CSA standards
- Drain not included
- 3" threshold base

Product characteristics:

- Made in North America
- Low Threshold
- Bestseller

Standard Colors:



White (001)

Certifications

MAAX products adhere to one or more of the following certifications:



MAAX

B3Round 4834 Acrylic Configurable Shower Base

Model number:

410002-506-001-000

Dimensions: 47.875" x 33.875" x 4"

Installation:

Material: Acrylic

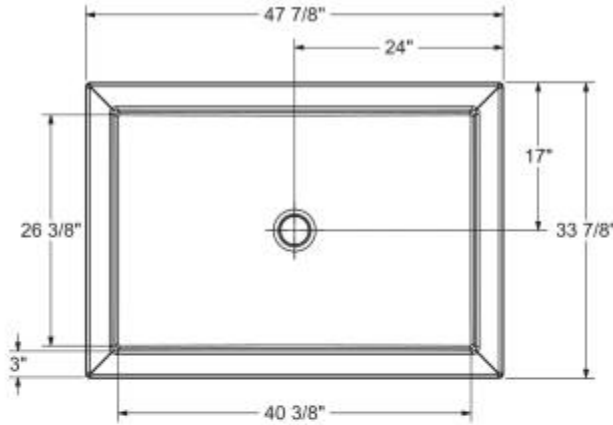

Dimensions

48 x 34 x 4 In.
(1216 x 860 x 102 mm)

Weight

44 lbs - 20 kg

Shape

Rectangular

Drain location:

Center

This technical drawing is universal for every 4834 configuration.

Integrated tiling flange : 1" height x 1/4" thick (not shown)
Tiling flange position is determined by chosen configuration.

All dimensions are approximate. Structure measurements must be verified against the unit to ensure proper fit.

Project:

Contractor:

Representative:

Date:

Tel:

Notes:

MAAX