

B3Round 6036 Acrylic Configurable Shower Base

Model number:

410006-505-001-002

Dimensions: 59.875" x 35.875" x 4"

Installation:

Material: Acrylic



Standard Features:

- Acrylic rectangular shower base with round drain
- Smooth floor
- Right, left, back end or center drain
- Certain configurations available with Stabili-T anti-slip bottom meeting ADA, ANSI or CSA standards
- Drain not included
- 3" threshold base

Product characteristics:

- Made in North America
- Utile Compatible
- Bestseller

Standard Colors:



White (001)

Certifications

MAAX products adhere to one or more of the following certifications:



MAAX

B3Round 6036 Acrylic Configurable Shower Base

Model number:

410006-505-001-002

Dimensions: 59.875" x 35.875" x 4"

Installation:

Material: Acrylic

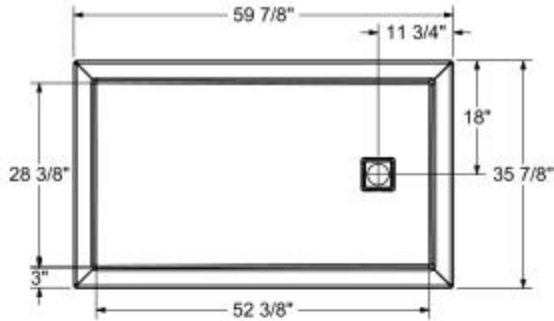

DRAIN INCLUDED
ON B3 SQUARE ONLY

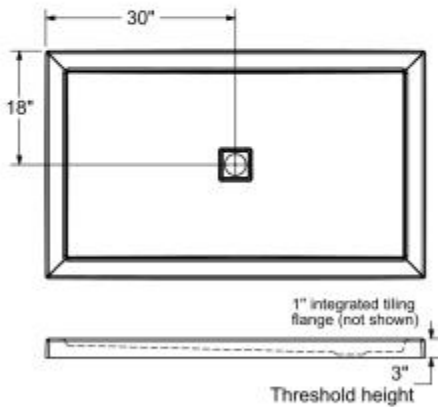

This technical drawing is universal for every 6036 configuration.

Integrated tiling flange : 1" height x 1/4" thick (not shown)
Tiling flange position is determined by chosen configuration.

All dimensions are approximate. Structure measurements
must be verified against the unit to ensure proper fit.

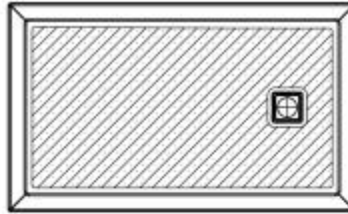

The hatched area represent the anti-slip surface

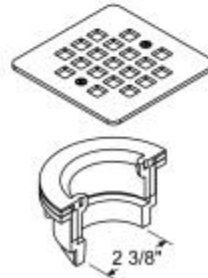
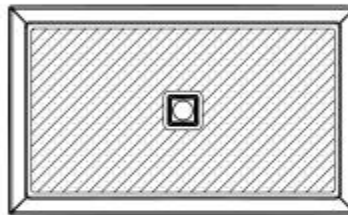

Dimensions

60 x 36 x 4 In.
(1521 x 911 x 102 mm)

Weight

62 lbs - 28 kg

Shape

Rectangular

Drain location:

Center

Left

Right

Project:

Contractor:

Representative:

Date:

Tel:

Notes:

MAAX