

# B3Square 4834 Acrylic Configurable Shower Base

**Model number:**

420002-504-001-100

**Dimensions:** 47.875" x 33.875" x 4"

**Installation:**

**Material:** Acrylic

## Standard Features:

- Acrylic rectangular shower base with square drain
- 3 in. threshold and smooth floor
- Certain configurations available with Stabili-T anti-slip bottom meeting ADA, ANSI or CSA standards
- Center drain
- Square chrome grid and ABS drain included (Upgrade PVC Option available)
- Multiple grid finishes available

## Product characteristics:

- Made in Canada
- Low Threshold
- Bestseller

## Standard Colors:



White (001)

## Certifications

MAAX products adhere to one or more of the following certifications:



# MAAX

# B3Square 4834 Acrylic Configurable Shower Base

**Model number:**

420002-504-001-100

**Dimensions:** 47.875" x 33.875" x 4"

**Installation:**

**Material:** Acrylic

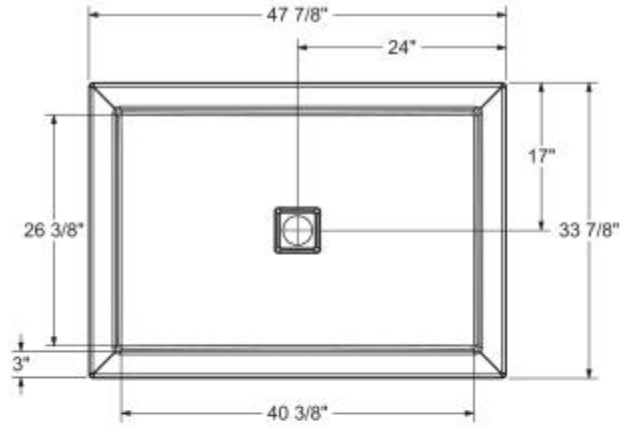

## Dimensions

48 x 34 x 4 In.  
(1216 x 860 x 102 mm)

## Weight

44 lbs - 20 kg

## Shape

Rectangular

## Drain location:

Center

DRAIN INCLUDED  
ON B3 SQUARE ONLY



1" integrated tiling  
flange (not shown)



This technical drawing is universal for every 4834 configuration.

Integrated tiling flange : 1" height x 1/4" thick (not shown)  
Tiling flange position is determined by chosen configuration.

All dimensions are approximate. Structure measurements  
must be verified against the unit to ensure proper fit.

Project:

Contractor:

Representative:

Date:

Tel:

Notes:

# MAAX