

B3X 3636 Acrylic Corner Shower Base

Model number:

420021-540-001-000

Dimensions: 35.875" x 35.875" x 4"

Installation:

Material: Acrylic

Standard Features:

- 3 1/4 in. threshold acrylic shower base with square center drain
- Optimized floor design improving showering space
- Available with Stabili-T anti-slip bottom meeting ADA, ANSI or CSA requirements
- 2 1/2 in. high tiling flanges to ensure watertightness
- Integrated weep holes providing superior water management
- Square chrome grid and ABS drain included (Upgrade PVC Option available)

Product characteristics:

- Made in North America
- Integrated Weep Holes
- Recommended for Tile Applications Only



Standard Colors:



White (001)

Certifications

MAAX products adhere to one or more of the following certifications:



Recommended products (Visit our website for a complete list of our recommended products)

No	Description
<input type="checkbox"/> 137448	Radia Square 36 x 36 x 71 1/2 in. 6 mm Sliding Shower Door for Corner Installation
<input type="checkbox"/> 136675	Reveal 71 Return Panel for 36 in. Base
<input type="checkbox"/> 136676	Reveal 71 32 1/2-35 1/2 x 71 1/2 in. 8mm Pivot Shower Door for Alcove Installation

MAAX

B3X 3636 Acrylic Corner Shower Base

Model number:

420021-540-001-000

Dimensions: 35.875" x 35.875" x 4"

Installation:

Material: Acrylic

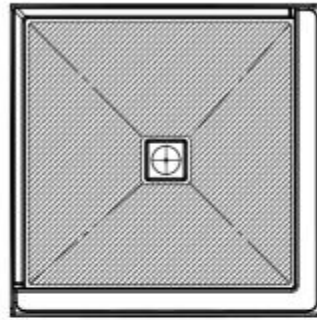
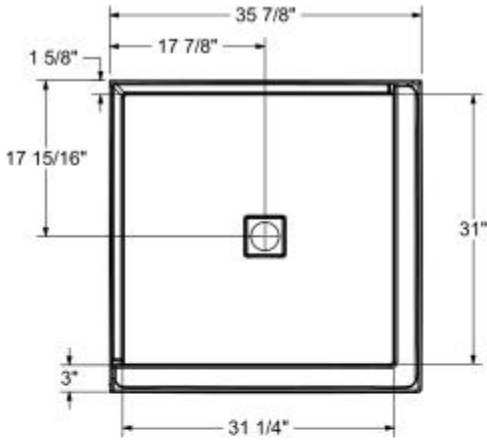

The hatched area represent the antislip surface

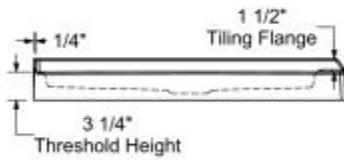

DRAIN INCLUDED ON B3 SQUARE ONLY



All dimensions are approximate. Structure measurements must be verified against the unit to ensure proper fit.

Dimensions

36 x 36 x 4 In.
(911 x 911 x 102 mm)

Weight

35 lbs - 15 3/4 kg

Shape

Square

Drain location:

Center

Project:

Contractor:

Representative:

Date:

Tel:

Notes:

MAAX