

Pose 6632 IF Acrylic Corner Left Bathtub

Model number:

106205-R-103-001

Dimensions: 65.75" x 31.625" x 23.5"

Installation: Corner

Material: Acrylic



Standard Features:

- Rectangular shape bathtub with choices of two deck heights (3/8 or 2 in.) Please specify when ordering.
- Integrated flange (IF) for corner installation
- Textured floor
- Ample deck space for faucet installation
- Right or left drain available

Product characteristics:

- Integrated Tiling Flange
- Easy Installation
- Textured Floor

Systems:

- Whirlpool
- Combined Whirlpool/Aeroeffect
- Aeroeffect

Standard Colors:



White (001)



Bone (004)



Biscuit (007)

Certifications

MAAX products adhere to one or more of the following certifications:



MAAX

Pose 6632 IF Acrylic Corner Left Bathtub

Model number:

106205-R-103-001

Dimensions: 65.75" x 31.625" x 23.5"

Installation: Corner

Material: Acrylic

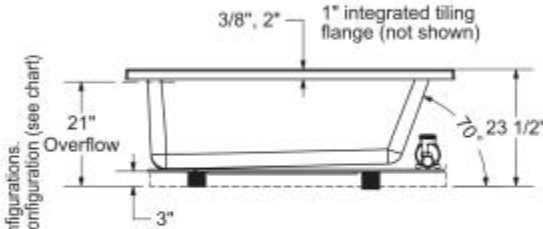
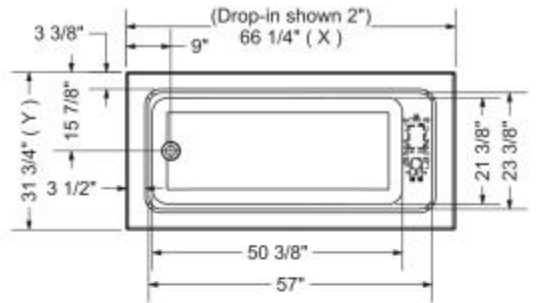

Technical drawing is universal for all 6632 configurations. External dimension (X,Y) vary depending on configuration (see chart)

	DROP IN 2"	DROP IN 3/8"	ALCOVE / CORNER
X	66 1/4"	66"	65 3/4"
Y	31 3/4"	31 5/8"	31 5/8"

Wood support design may vary.
 Integrated tiling flange: 1" height X 1/4" thickness (not shown)
 Tiling flange position is determined by chosen configuration.
 All dimensions are approximate.
 Structure measurement must be verified against the unit to ensure proper fit.

WHIRLPOOL SYSTEM

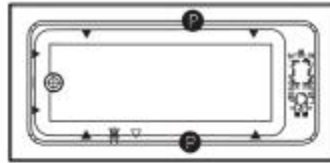

AIR SYSTEM

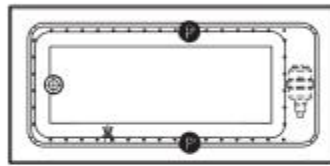

- : Indicates optional grab bar positioning
- ▲ : Indicates whirlpool jets positioning
- △ : Indicates suction positioning
- : Indicate airjets positioning
- ☒ : Indicates chromatherapy light positioning

APRON (alcove version only)

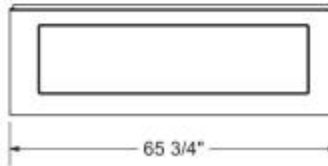

Dimensions

65 3/4 x 31 3/4 x 23 1/2 In.
 (1670 x 803 x 597 mm)

Water Capacity

72 gallons - 273 liters

Weight

67 lbs - 30 1/2 kg

Bathing Well

57 In. x 23 1/2 In.

Deep Sump Height

19.875 In. - 505 mm

Deck Width

3.375 In. - 86 mm

Drain location:

Left

Right

Project:

Contractor:

Representative:

Date:

Tel:

Notes:

MAAX