

Exhibit 7232 IFS AFR Acrylic Alcove Bathtub

Model number:

106226-L-003-001

Dimensions: 71.875" x 32" x 20"

Installation: Alcove

Material: Acrylic

Standard Features:

- Rectangular shape bathtub in alcove installation
- Available in Above-the-Floor Rough (AFR) or not
- Minimalist look with discreet armrests and textured floor
- Integrated tiling flange
- When equipped with a system, the unit comes with an access panel

Product characteristics:

- Made in North America
- Integrated Armrest
- Integrated Tiling Flange and Skirt

Systems:

Whirlpool
Combined Whirlpool/Aeroeffect
Aeroeffect



Standard Colors:



White (001)



Bone (004)



Biscuit (007)

Certifications

MAAX products adhere to one or more of the following certifications:



MAAX

Exhibit 7232 IFS AFR Acrylic Alcove Bathtub

Model number:

106226-L-003-001

Dimensions: 71.875" x 32" x 20"

Installation: Alcove

Material: Acrylic

Dimensions

72 x 32 x 20 In.
(1826 x 813 x 508 mm)

Water Capacity

59 gallons - 223 liters

Weight

92 lbs - 41 3/4 kg

Bathing Well

66 1/2 In. x 26 In.

Deep Sump Height

16.375 In. - 416 mm

Deck Width

4 In. - 102 mm

Drain location:

Left

Right

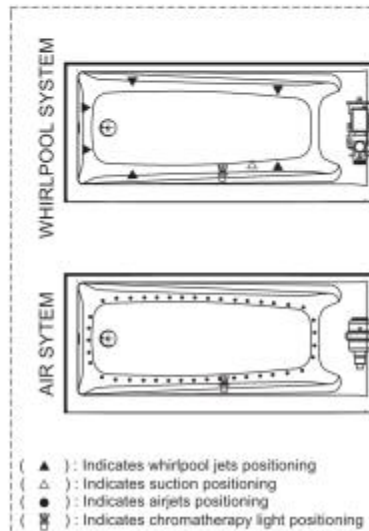
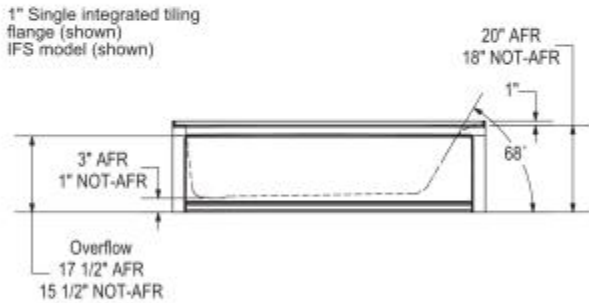
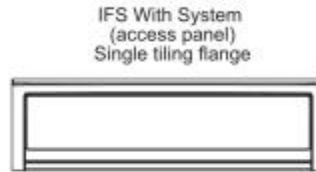
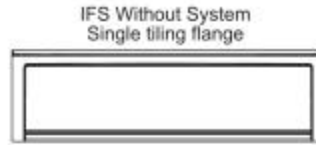
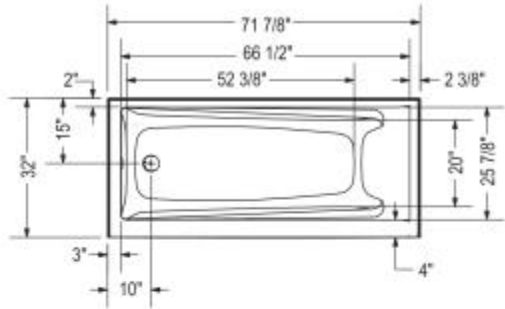

Technical drawing is universal for all Exhibit 7232 configurations.

Wood support design may vary.
Single Integrated tiling flange: 1" height x 1/4" thickness (shown)

All dimensions are approximate.
Structure measurement must be verified against the unit to ensure proper fit.

Project: _____

Contractor: _____

Representative: _____

Date: _____

Tel: _____

Notes: _____

MAAX