

INSTALLATION INSTRUCTIONS



The Transitional Bathroom Collection

Installation & User Guide

3 HOLE WALL MOUNTED SETS AND WALL VALVES

LAV SETS

- U.3320 (SPOUT)
- U.3321LS
- U.3322X
- U.3036TLS (LEVER TRIM)
- U.3037X (X-TOP TRIM)

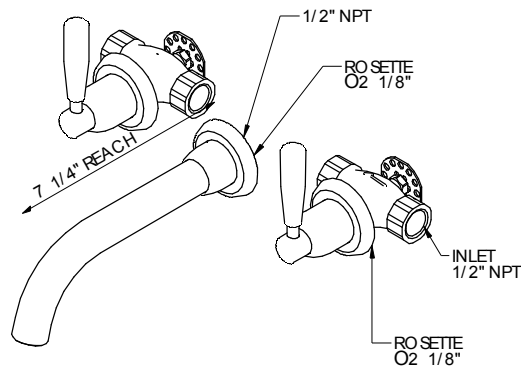

TUB SETS

- U.3330 (SPOUT)
- U.3331LS
- U.3332X

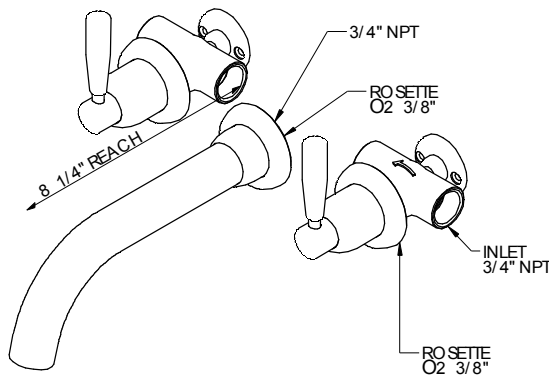

Temp Range:
Min 34°F
Max 185°F

Recommended
Working Pressure:
Min 15 psi
Max 75 psi

Ideal performance obtained with equal hot & cold pressures.

INSTALLATION INSTRUCTIONS

The Transitional Bathroom Collection Installation & User Guide

Congratulations on the purchase of your Perrin & Rowe bathroom product. Correctly installed and with sensible care, this product will give you many years of trouble free service.

IMPORTANT INFORMATION

Before you proceed... We recommend you engage the services of a registered plumber to install this product.

In addition to the guide below it is essential that the written information overleaf is carefully read and understood.

Flush the plumbing system before installation.

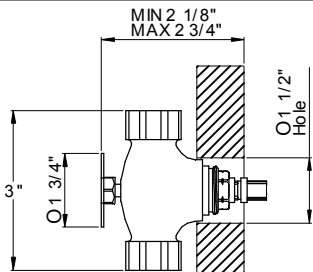

MIN 2 1/8"
MAX 2 3/4"

O 1 3/4"

3"

O 1 1/2" Hole

• U.3320 • U.3321LS • U.3322X
WALL LAV SETS

- Follow placement dimensions supplied for installation.
- When installing products make sure allowance is made for tiles etc.
- Cavity should be sufficient to allow for servicing of valves.
- Screw 1/2"NPT spout onto suitable shank using thread sealing materials sparingly.
- Push rosette back to wall surface.

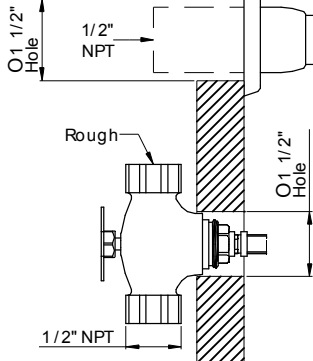

O 1 1/2" Hole

1/2" NPT

Rough

O 1 1/2" Hole

1/2" NPT

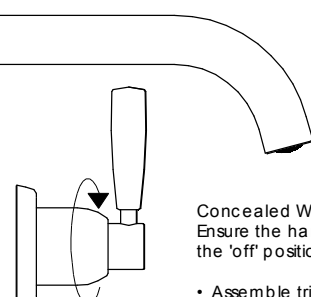

Concealed Wall Valve
Ensure the handle is vertical when the valve is in the 'off' position.

- Assemble trim to rough ensuring handle is aligned correctly. If it is not, remove and turn a few splines until correct alignment can be achieved.

Special Note for Installing a Pair of Lever Wall Valves

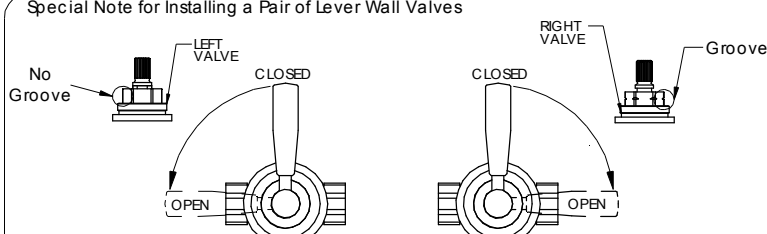

No Groove

LEFT VALVE

RIGHT VALVE

Groove

CLOSED

CLOSED

OPEN

OPEN

OPERATION

- This tap is fitted with quarter-turn ceramic disc valve units. Water flow from off to fully on is achieved by rotating the handles a quarter-turn.
- Ceramic disc valves are available opening in a clockwise or anti-clockwise direction. Should the handle of an installed tap operate in the wrong direction, this can be remedied by changing the ceramic disc valve to the other version.

INSTALLATION INSTRUCTIONS

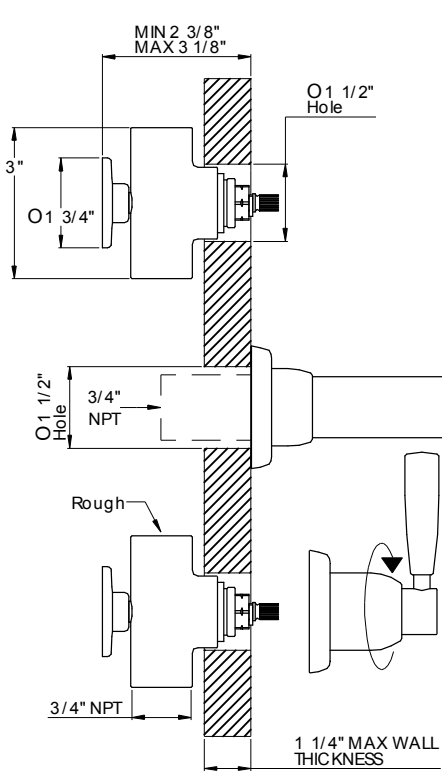

MIN 2 3/8"
MAX 3 1/8"

O1 3/4"

3"

O1 1/2" Hole

3/4" NPT

Rough

3/4" NPT

1 1/4" MAX WALL THICKNESS

• U.3330 • U.3331LS • U.3332X
WALL TUB SETS

- Follow placement dimensions supplied for installation.
- When installing products make sure allowance is made for tiles etc.
- Cavity should be sufficient to allow for servicing of valves.
- Screw 3/4"NPT spout onto suitable shank using thread sealing materials sparingly.
- Push rosette back to wall surface.

Concealed Wall Valve
Ensure the handle is vertical when the valve is in the 'off' position.

- Assemble trim to rough ensuring handle is aligned correctly. If it is not, remove and turn a few splines until correct alignment can be achieved.

BEFORE USE

- Carefully check the installation for leaks.
- If further building work is to be carried out in the vicinity, cover the tap with a plastic bag to avoid damaging the finish.
- Please ensure that the installation complies with the local plumbing codes.

CARE & MAINTENANCE

- Occasional cleaning with warm soapy water, followed by a polish with a soft cloth is all that is required to keep the plated finish in good condition.
- If you wish to occasionally polish your tap and it has a Chrome, Nickel or Pewter finish, we recommend a gentle metal cleaner such as AUTOSOL metal polish, which is available from hardware and automotive parts stores.
- Do not use any cleaners on Gold or English Bronze taps.
- Do not use proprietary abrasive liquids, powders, or pads to clean the product. You will damage the plated finish and void your warranty.