

Installation Instructions

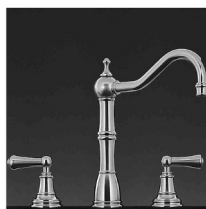

U.4768X-2
U.4769L-2
U.4770X-2
U.4771L-2
U.4775X-2
U.4776L-2

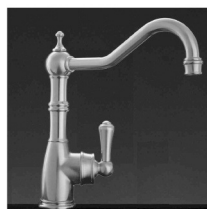

U.4739-2
U.4741-2
U.4746-2
U.4747-2

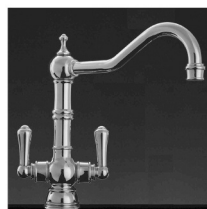

U.4759-2
U.4761-2
U.4766-2



U.4735X-2
U.4736L-2

Installation Instructions

Congratulations on the purchase of your Perrin & Rowe Kitchen Faucet.

Correctly installed and with sensible care, it will give many years of trouble free service.

Before you proceed... We recommend you engage the services of a registered plumber to install this product.

Read the instructions and diagrams in this leaflet carefully.

Preparation

This range of Perrin & Rowe kitchen faucets features a spout that allows hot and cold water to mix before discharge.

- 1) **Flush the plumbing system before installing the faucet.** This is to avoid plumbing residues clogging the aerator, or possibly damaging the ceramic valves. This is especially important where extensive plumbing work has been carried out.

Check List

- Temperature of the hot water supply does not exceed 185 °F.
- Recommended minimum water supply pressure - 15 psi.
- Recommended maximum water supply pressure - 75 psi.
- Ideal performance obtained with equal hot & cold pressures.

Centerbody Assembly for Models :

U.4735X-2, U.4736L-2, U.4739-2, U.4741-2, U.4746-2, U.4747-2, U.4759-2, U.4761-2, U.4766-2, U.4768X-2, U.4769L-2, U.4770X-2, U.4771L-2, U4775X-2, U4776L-2 - Refer to Figures 1, 2, 2A, 3 & 4

- 2) Hot supply should be on the left when viewed from the front of the fitting.
- 3) U.4739-2, U.4741-2, U.4746-2, U.4747-2 - Lever should be on the right when viewed from the front of the fitting. Hole center a minimum distance of 2 1/2" from wall. The Hot supply should be at rear of the mixer - see figure 3.
- 4) Single Hole mixers and U.4735X-2, U.4736L-2, U.4759-2, U.4768X-2, U.4769LU-2, 4770X-2, U.4771L-2, U4775X,-2 U.4776L-2 centerbody require a 1 3/8" diameter hole through the surface they are to be installed on. Maximum counter-top thickness 2 1/2" - see figures 2, 2A & 4 .
- 5) Insert the flexible connections through the hole ensuring that the base ring and seal are in place between the mixer and mounting surface.
- 6) From the underside of the counter-top, place the clamp plate on securing stud and using the box spanner supplied, put fixing nut in spanner and tighten until mixer is held firmly in position. See Figure 1.

Sidevalve Assembly for Models :

U.4735X-2, U.4736L-2, U.4768X-2, U.4769L-2, U.4770X-2, U.4771L-2, U4775X-2, U.4776L-2 - Refer to Figure 2 and 2A.

- 7) The side valve assemblies require a 1 3/8" diameter hole through the counter-top surface.

- 8) Undo and remove cover, handle, rosette, base ring and base seal.
- 9) From underside pass shank through the hole in the counter-top then place base ring and seal over shank, screw rosette with base seal onto shank until the thread can be seen above the rosette.

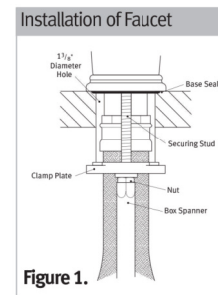

Figure 1.

- 10) Ensure the connection for flexible hose is facing the nozzle and tighten securing the nut up to the underside of the counter top by hand to stop sidevalve from rotating.
- 10a) Spacer washer to be used in installations where work surface has a thickness ranging from 1/8" to 1 7/8"
- 11) Connect flexible hose from nozzle to sidevalve outlet. Screw the cover and handle onto the sidevalve ensuring that the handle is correctly aligned. If not, remove and turn the plastic vernier insert a few splines until the correct alignment has been achieved.
- 12) Unscrew the rosette until it meets the cover and fully tighten securing nut and clamp plate to underside of counter-top.
- 13) Connect the Hot & Cold water supplies to the side valve inlet hoses. To indicate the inlet hose, the arrow engraved on the side valve body should be pointing upwards.
- 14) **Important** - Check that flexible hoses are not twisted or kinked as this will restrict the flow.

HandSpray Assembly - Refer to Figures 2, 2A, 3 & 4.

- 15) The rinse units require a 1 1/8" diameter hole through the surface they are to be installed on.
- 16) Assemble rinse unit socket to the counter-top ensuring the base ring and seal are in place under body and the fiber seal is above the backnut.
- 17) Thread the tapered end of the rinse flex to the rinse unit ensuring the rubber seal is in place between them.
- 18) Pass the other end of the flex down through the socket, and screw the externally threaded end to the remaining hose at the base of the faucet.

Before Use

- 19) Turn on the Hot and Cold supplies to the faucet.
- 20) **Carefully check the installation for leaks.**
- 21) If further building work is to be carried out in the vicinity, cover the faucet with a plastic bag to avoid damaging the finish.
- 22) Please ensure that the installation complies with the local plumbing codes.

Installation Instructions

U.4768X-2, U.4769L-2, U.4770X-2, U.4771L-2, U.4775X-2, U.4776L-2 **Figure 2.**

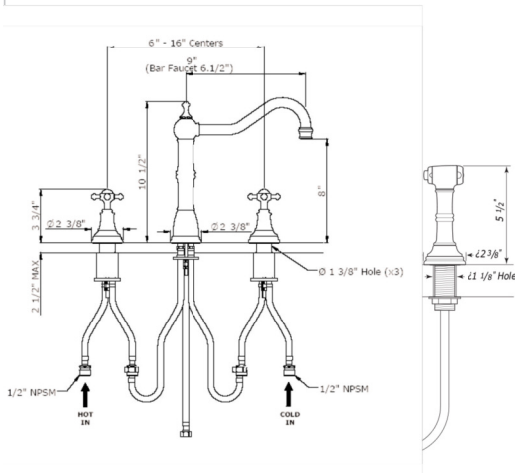

U.4735X-2, U.4736L-2 **Figure 2A.**

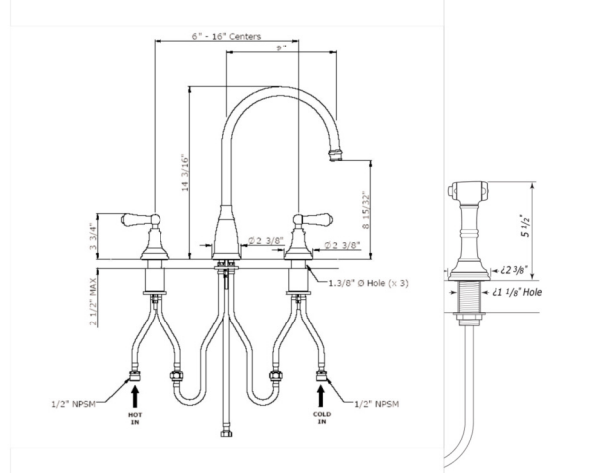

U.4739-2, U.4741-2, U.4746-2, U.4747-2 **Figure 3.**

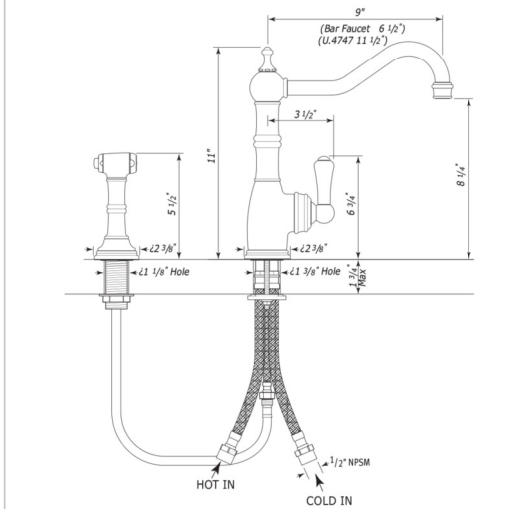

U. 4759-2, U.4761-2, U.4766-2 **Figure 4.**

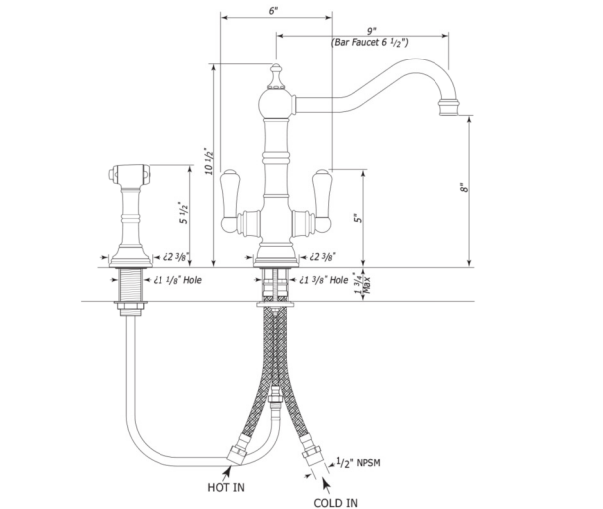

Operation

Ceramic disc valves are fitted as standard. Flow from FULLY OFF to FULLY ON is achieved by rotating the handles a quarter turn. The Aquataine mixer temperature is controlled by rotating the lever forwards or backwards, in line with the body of the faucet, to adjust Hot and Cold. The flow of water is increased by pushing the lever towards the body of the faucet.

Care & Maintenance

Occasional cleaning with warm soapy water, followed by a polish with a soft cloth is all that is required to keep the plated finish in good condition.

Do not use proprietary abrasive liquids, powders, or pads to clean the faucet. You will damage the plated finish and void your warranty.

A flow regulated aerator is fitted to the outlet of the spout, this may need occasional cleaning. This will be evident when the water flow slows down to an unacceptable level. To accomplish this unscrew the outlet in a counter-clockwise direction and remove the aerator, rinse thoroughly in clean water and re-install.

Installation Instructions

For maintenance and repairs, we recommend you employ a registered plumber. Before ordering spare parts, determine the correct reference number from the exploded diagram. Quote this number, and where appropriate, the color of your faucet.

**U.4768X-2, U.4769L-2, U.4770X-2
U.4771L-2, U.4775X-2, U.4776L-2**

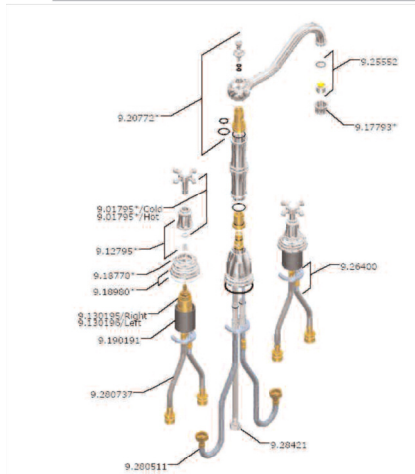

Hand Spray

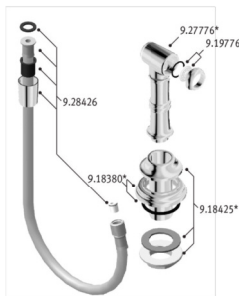

Warranty

For written details of the product warranty, please contact us at the address shown below



3 Parker
Irvine
CA 92618
(714) 557-1933

U.4735X-2, U.4736L-2

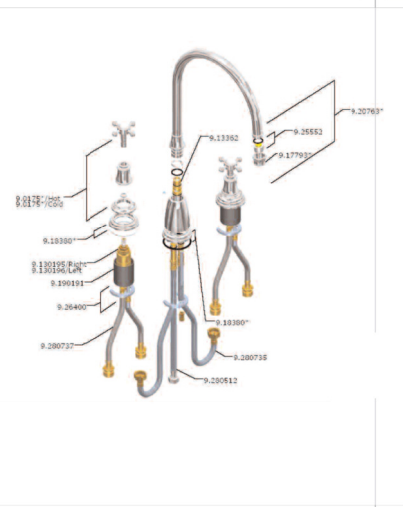

U.4759-2, U.4761-2, U.4766 -2

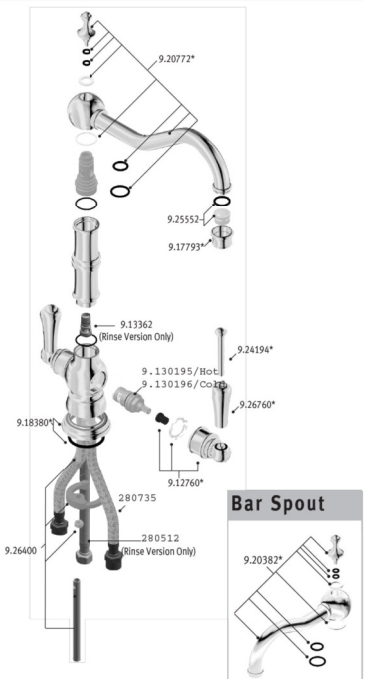

Bar Spout

U.4741-2, U.4746-2, U.4739-2, U.4747-2

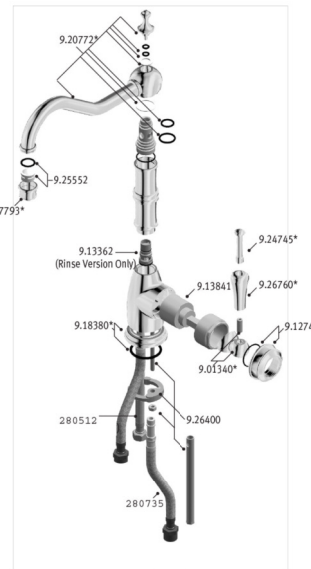

11" Spout U.4747-2

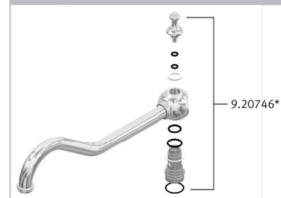

Bar Spout

