

Worcester Freestanding Bathtub

WOR-N-SW-NO / WOR-N-SW-OF

Top view

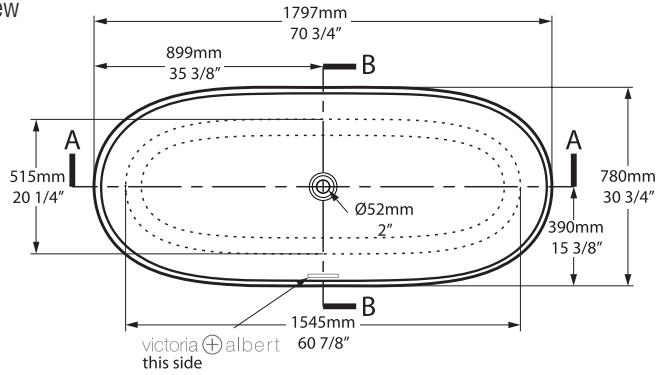

Front view

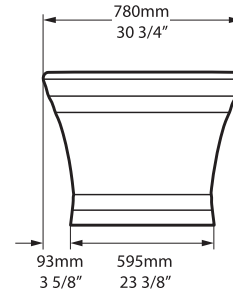

Side view

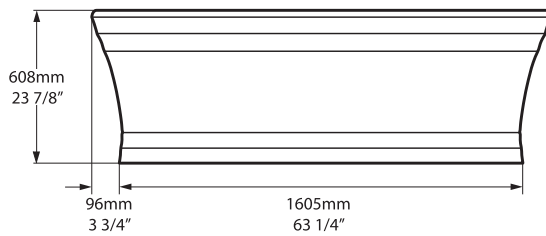

Section BB

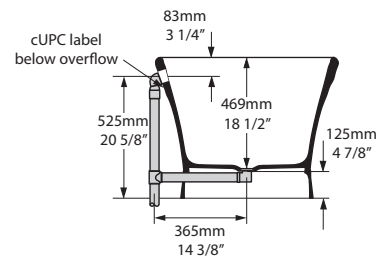

Section AA

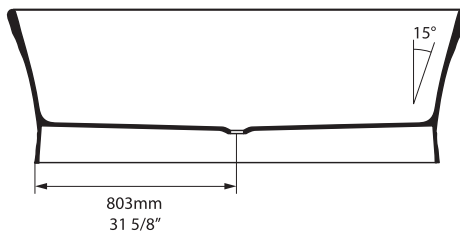

Rim detail

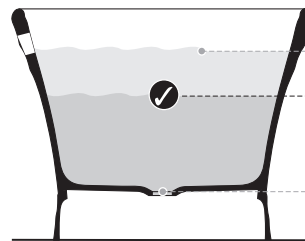
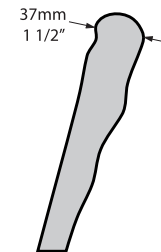

849 lbs	74 US gal
628 lbs	47½ US gal
231 lbs	0 US gal

BV-2.1_0068

Recommended drains: K-40E-xx / K-70-xx / K-50-xx

Drain Void: Features a void space underneath the bathtub for drain plumbing.

Note: K-36E/K-40E drains must be installed using all tools and washers included; do not use plumbers putty or silicone in the place of washers provided

- All measurements subject to +/-5% tolerance
- NO = no overflow hole
- OF = overflow hole

25
years

25 year warranty for residential use (unpainted product)
Garantie de 25 ans pour un utilisation résidentiel (produit non peint)
Garantía de 25 años para uso domestico (productos no pintados)

5
years

5 year warranty on drains
Garantie de 5 ans sur les drains
Garantía de 5 años para los drenajes

8
years

8 year warranty for commercial use (unpainted product)
Garantie de 8 ans pour un usage commercial (produit non peint)
Garantía de 8 años para uso comercial (productos no pintados)

2
years

2 year warranty on painted exterior
Pour les finitions extérieures peintes la garantie est de 2 ans
Acabados de pintura exterior tienen una garantía de 2 años



Massachusetts Code: Approved
cUPC listing by IAPMO: File No. 6574

