

**PRODUCT SPECIFICATIONS**

Crosstown® 18 Gauge Workstation Stainless Steel 22-1/2" x 18-1/2" x 8-3/4" Single Bowl Undermount Sink Kit. Sink is handmade/fabricated from 18 gauge 304 Stainless Steel with a Polished Satin finish, Rear Center drain placement, and Full spray sides and bottom with Sides and Bottom pads.

<b>Installation Type:</b>	Undermount
<b>Material:</b>	304 Stainless Steel
<b>Special Features:</b>	Workstation
<b>Finish:</b>	Polished Satin
<b>Gauge:</b>	18
<b>Sound Deadening:</b>	Full spray sides and bottom with Sides and Bottom pads
<b>Number of Bowls:</b>	1
<b>Sink Dimensions:</b>	22-1/2" x 18-1/2" x 9"
<b>Bowl 1 Dimensions:</b>	21" x 17" x 9"
<b>Drain Size:</b>	3-1/2" (89mm)
<b>Drain Location:</b>	Rear Center
<b>Minimum Cabinet Size:</b>	27"
<b>Mounting Hardware:</b>	Yes
<b>Template Included:</b>	Yes
<b>Cutout Template #:</b>	<a href="#">200000623</a>

Template is available for download at [elkay.com](http://elkay.com). CAD software will be required to open the template.

**Installation Profile:**

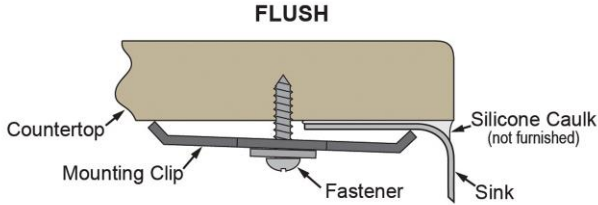

Designed to affix to the underside of any solid surface countertop.



**Included with Product:** LKDD Drain, CTXOBG1914 Bottom Grid, LKCB1217AC Cutting Board, LKC0717SS Colander, LKDR1317RU Roll-up Drying Rack, LKDR0717SS Drying Rack

A Century of Tradition and Quality. For more than 100 years, Elkay has been making innovative products and providing exceptional customer care. We take pride in offering plumbing products that make life easier, inspire change and leave the world a better place.



**Product Compliance:** ASME A112.19.3/CSA B45.4  
**Accessory:** ASME A112.18.2/CSA B125.2





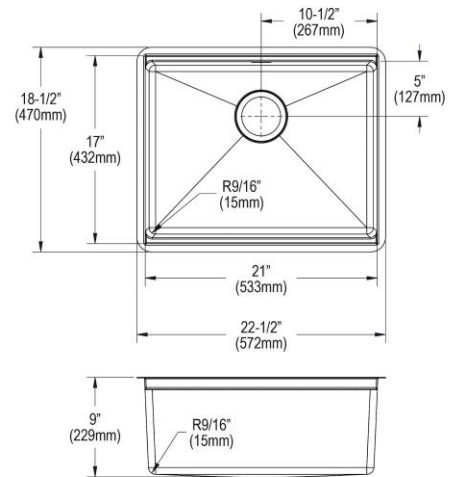

Sinks are listed by IAPMO® as meeting the applicable requirements of the Uniform Plumbing Code®, International Plumbing Code®, and National Plumbing Code of Canada.



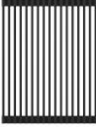

[Clean and Care Manual \(PDF\)](#)  
[Installation Instructions \(PDF\) - 1000005239](#)  
[Installation Instructions \(PDF\) - 1000005235](#)  
[Warranty \(PDF\)](#)

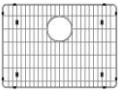



PART: \_\_\_\_\_ QTY: \_\_\_\_\_  
PROJECT: \_\_\_\_\_  
CONTACT: \_\_\_\_\_  
DATE: \_\_\_\_\_  
NOTES: \_\_\_\_\_  
APPROVAL: \_\_\_\_\_

In keeping with our policy of continuing product improvement, Elkay reserves the right to change product specifications without notice. Please visit [elkay.com](http://elkay.com) for the most current version of Elkay product specification sheets. This specification describes an Elkay product with design, quality, and functional benefits to the user. When making a comparison of other producers' offerings, be certain these features are not overlooked. Latest version of the spec sheet available: [https://www.elkayfiles.com/spec-sheets/ECTRU21169W\\_spec.pdf](https://www.elkayfiles.com/spec-sheets/ECTRU21169W_spec.pdf)

Included Accessories		
<a href="#">LKDR0717SS</a>	Crosstown Stainless Steel 16-7/8" x 6-3/4" x 4-1/4" Drying Rack with Wood Handles <a href="#">Spec Sheet (PDF)</a>	
<a href="#">LKDR1317RU</a>	Crosstown Black Silicone 11-7/8" x 16-3/4" x 3/8" Drying Rack <a href="#">Spec Sheet (PDF)</a>	
<a href="#">LKDD</a>	3-1/2" Drain Fitting Deep Strainer Basket <a href="#">Spec Sheet (PDF)</a>	
<a href="#">CTXOBG1914</a>	Crosstown® Stainless Steel 19-3/8" x 14-1/8" x 1-1/4" Bottom Grid w/Rear Center Drain Opening <a href="#">Spec Sheet (PDF)</a>	
<a href="#">LKCB1217AC</a>	Acacia Hardwood 12" x 16-7/8" x 1" Cutting Board <a href="#">Spec Sheet (PDF)</a>	
<a href="#">LKC0717SS</a>	Crosstown® Stainless Steel 16-7/8" x 6-3/4" x 3-1/8" Colander with Wood Handles <a href="#">Spec Sheet (PDF)</a>	

Optional Accessories		
<a href="#">CTXOBG1914</a>	Crosstown® Stainless Steel 19-3/8" x 14-1/8" x 1-1/4" Bottom Grid w/Rear Center Drain Opening <a href="#">Spec Sheet (PDF)</a>	
<a href="#">LKC0717SS</a>	Crosstown® Stainless Steel 16-7/8" x 6-3/4" x 3-1/8" Colander with Wood Handles <a href="#">Spec Sheet (PDF)</a>	
<a href="#">LKCB1217AC</a>	Acacia Hardwood 12" x 16-7/8" x 1" Cutting Board <a href="#">Spec Sheet (PDF)</a>	
<a href="#">LKDD</a>	3-1/2" Drain Fitting Deep Strainer Basket <a href="#">Spec Sheet (PDF)</a>	

In keeping with our policy of continuing product improvement, Elkay reserves the right to change product specifications without notice. Please visit [elkay.com](http://elkay.com) for the most current version of Elkay product specification sheets. This specification describes an Elkay product with design, quality, and functional benefits to the user. When making a comparison of other producers' offerings, be certain these features are not overlooked. Latest version of the spec sheet available: [https://www.elkayfiles.com/spec-sheets/ECTRU21169W\\_spec.pdf](https://www.elkayfiles.com/spec-sheets/ECTRU21169W_spec.pdf)

<a href="#">LKAV2061</a>	Avado® Single Hole Kitchen Faucet with Semi-professional Spout and Lever Handle <a href="#">Spec Sheet (PDF)</a>	
<a href="#">LKDR1317RU</a>	Crosstown Black Silicone 11-7/8" x 16-3/4" x 3/8" Drying Rack <a href="#">Spec Sheet (PDF)</a>	

*In keeping with our policy of continuing product improvement, Elkay reserves the right to change product specifications without notice. Please visit [elkay.com](http://elkay.com) for the most current version of Elkay product specification sheets. This specification describes an Elkay product with design, quality, and functional benefits to the user. When making a comparison of other producers' offerings, be certain these features are not overlooked. Latest version of the spec sheet available: [https://www.elkayfiles.com/spec-sheets/ECTRU21169W\\_spec.pdf](https://www.elkayfiles.com/spec-sheets/ECTRU21169W_spec.pdf)*