

PRODUCT SPECIFICATIONS

Crosstown[®] 16 Gauge Workstation Stainless Steel 25-1/2" x 18-1/2" x 9" Single Bowl Undermount Sink Kit with Filtered Beverage Faucet. Sink is handmade/fabricated from 16 gauge 304 Stainless Steel with a Polished Satin finish, Rear Right drain placement, and Full spray sides and bottom with Sides and Bottom pads.

Installation Type:	Sink Kits, Undermount
Material:	304 Stainless Steel
Special Features:	Workstation
Finish:	Polished Satin
Gauge:	16
Sound Deadening:	Full spray sides and bottom with Sides and Bottom pads
Number of Bowls:	1
Sink Dimensions:	25-1/2" x 18-1/2" x 9"
Bowl 1 Dimensions:	24" x 17" x 9"
Drain Size:	3-1/2" (89mm)
Drain Location:	Rear Right
Minimum Cabinet Size:	30"
Mounting Hardware:	Included
Template Included:	Yes
Cutout Template #:	1000005510

Template is available for download at [elkay.com](#). CAD software will be required to open the template.

Special Note: Kitchen faucet sold separately. Reserve Selection products are sold exclusively, in-store and online, through authorized wholesalers.

Installation Profile:

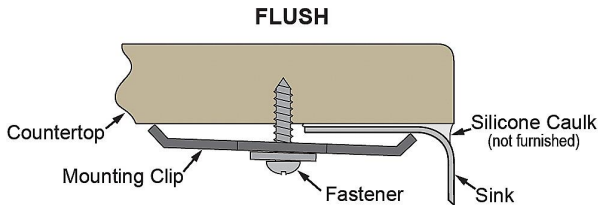

Designed to affix to the underside of any solid surface countertop.



Included with Product:

LKAV71FLS Beverage Faucet and Filter with sink, wood cutting board, wood-handled colander & drying rack, roll-up drying rack, bottom grid(s), drain(s)

A Century of Tradition and Quality. For more than 100 years, Elkay has been making innovative products and providing exceptional customer care. We take pride in offering plumbing products that make life easier, inspire change and leave the world a better place.



Product Compliance:

Faucet:

ASME A112.19.3/CSA B45.4
ASME A112.18.1/CSA B125.1
NSF 61
NSF 372 (lead free)

Accessory:

ASME A112.18.2/CSA B125.2
NSF 42
NSF 53
NSF 401



Sinks are listed by IAPMO[®] as meeting the applicable requirements of the Uniform Plumbing Code[®], International Plumbing Code[®], and National Plumbing Code of Canada.

- [Clean and Care Manual \(PDF\)](#)
- [Clean and Care Manual \(PDF\)](#)
- [Installation Instructions \(PDF\) - 1000005239](#)
- [Installation Instructions \(PDF\) - 1000005235](#)
- [Installation Instructions \(PDF\) - 2000000477](#)
- [Warranty \(PDF\)](#)

PART: _____ QTY: _____

PROJECT: _____







CONTACT: _____

DATE: _____

NOTES: _____

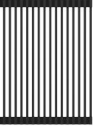
APPROVAL: _____

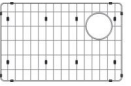

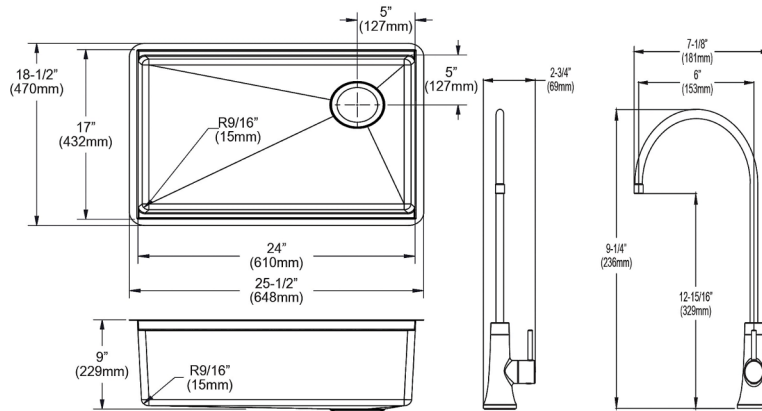

In keeping with our policy of continuing product improvement, Elkay reserves the right to change product specifications without notice. Please visit [elkay.com](#) for the most current version of Elkay product specification sheets. This specification describes an Elkay product with design, quality, and functional benefits to the user. When making a comparison of other producers' offerings, be certain these features are not overlooked.

Included Accessories		
LKCB1217AC	Acacia Hardwood 12" x 16-7/8" x 1" Cutting Board Spec Sheet (PDF)	
LKC0717SS	Crosstown® Stainless Steel 16-7/8" x 6-3/4" x 3-1/8" Colander with Wood Handles Spec Sheet (PDF)	
LKDR1317RU	Crosstown Black Silicone 11-7/8" x 16-3/4" x 3/8" Drying Rack Spec Sheet (PDF)	
LKDD	3-1/2" Drain Fitting Deep Strainer Basket Spec Sheet (PDF)	
CTXBG2214	Crosstown® Stainless Steel 22-1/4" x 14-1/4" x 1-1/4" Bottom Grid Spec Sheet (PDF)	
LKAV71FLS	Avado Drinking Water Faucet Lustrous Steel w/71300C WaterSentry® PFAS + Lead + Microplastics NSF/ANSI Certified Filter Spec Sheet (PDF)	
LKDR0717SS	Crosstown Stainless Steel 16-7/8" x 6-3/4" x 4-1/4" Drying Rack with Wood Handles Spec Sheet (PDF)	

In keeping with our policy of continuing product improvement, Elkay reserves the right to change product specifications without notice. Please visit elkay.com for the most current version of Elkay product specification sheets. This specification describes an Elkay product with design, quality, and functional benefits to the user. When making a comparison of other producers' offerings, be certain these features are not overlooked.



Optional Accessories

<p>LK99</p>	<p>Deluxe 3-1/2" Drain Type 304 Stainless Steel Body Strainer Basket Rubber Seal and Tailpiece Spec Sheet (PDF)</p>	
<p>LKAV3031</p>	<p>Avado® Single Hole Kitchen Faucet with Pull-down Spray and Forward Only Lever Handle Spec Sheet (PDF)</p>	
<p>LKAV4061</p>	<p>Avado® Single Hole Kitchen Faucet with Semi-professional Spout Forward Only Lever Handle Spec Sheet (PDF)</p>	
<p>ERF750</p>	<p>WaterSentry® Lead + Microplastics NSF/ANSI Certified Residential 750 Gal 12 Month Filter Spec Sheet (PDF)</p>	

In keeping with our policy of continuing product improvement, Elkay reserves the right to change product specifications without notice. Please visit elkay.com for the most current version of Elkay product specification sheets. This specification describes an Elkay product with design, quality, and functional benefits to the user. When making a comparison of other producers' offerings, be certain these features are not overlooked.