

**PRODUCT SPECIFICATIONS**

Polymer 3-1/2" Disposer Flange with Removable Basket Strainer and Rubber Stopper. Overall dimensions are 4-1/2" x 4-1/2" x 2-1/8". Made of Polymer.

<b>Material:</b>	Polymer
<b>Dimensions:</b>	4-1/2" x 4-1/2" x 2-1/8"
<b>Shipping Weight:</b>	.5 lbs.

- **COLOR MATCH:** Coordinate your drain to match the color of your Elkay Quartz Classic® or Quartz Luxe® sink
- **POLYMER CONSTRUCTION:** Material is fully infused with color and will not chip or scratch off from daily use
- **BASKET STRAINER AND STOPPER:** Strainer catches food and waste from going down the drain. Use stopper to fill sink with water for washing and soaking
- **CORROSION RESISTANT:** Constructed of high-quality material to resist rust and stains, keeping drain looking great for years to come
- **DISPOSAL READY:** Designed for garbage disposals that accommodate 4-1/2" flange or select InSinkErator disposers
- **EASY CLEANING:** Wash by hand with a mild detergent and soft cloth; rinse



A Century of Tradition and Quality.  
For more than 100 years, Elkay has been making innovative products and providing exceptional customer care. We take pride in offering plumbing products that make life easier, inspire change and leave the world a better place.

**Product Compliance:** ASME A112.18.2/CSA B125.2  
Drains are listed by IAPMO® as meeting the applicable requirements of the Uniform Plumbing Code®, International Plumbing Code®, and National Plumbing Code of Canada.



[Clean and Care Manual \(PDF\)](#)  
[Installation Instructions \(PDF\) - 100003753](#)  
[Warranty \(PDF\)](#)

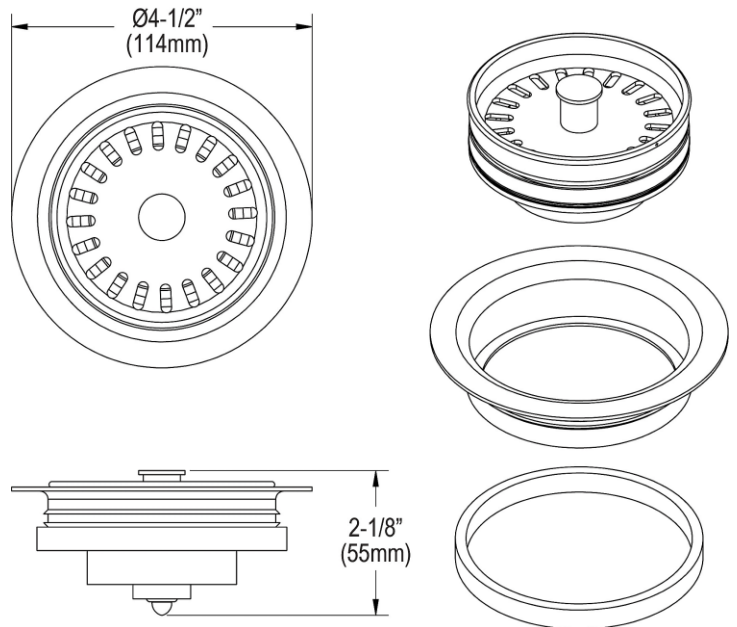

PART: \_\_\_\_\_ QTY: \_\_\_\_\_

PROJECT: \_\_\_\_\_

CONTACT: \_\_\_\_\_

DATE: \_\_\_\_\_

NOTES: \_\_\_\_\_

APPROVAL: \_\_\_\_\_

*In keeping with our policy of continuing product improvement, Elkay reserves the right to change product specifications without notice. Please visit [elkay.com](http://elkay.com) for the most current version of Elkay product specification sheets. This specification describes an Elkay product with design, quality, and functional benefits to the user. When making a comparison of other producers' offerings, be certain these features are not overlooked.*