

**PRODUCT SPECIFICATIONS**

Elkay Lustertone™ Classic Stainless Steel 17" x 20" x 6", Single Bowl Drop-in ADA Sink. Sink is manufactured from 18 gauge 304 Stainless Steel with a Lustrous Satin finish, Rear Center drain placement, and Bottom only pads.

<b>Installation Type:</b>	Drop-in
<b>Material:</b>	304 Stainless Steel
<b>Finish:</b>	Lustrous Satin
<b>Gauge:</b>	18
<b>Sound Deadening:</b>	Bottom only pads
<b>Number of Bowls:</b>	1
<b>Sink Dimensions:</b>	17" x 20" x 6"
<b>Bowl 1 Dimensions:</b>	14" x 14" x 5-7/8"
<b>Drain Size:</b>	3-1/2" (89mm)
<b>Drain Location:</b>	Rear Center
<b>Minimum Cabinet Size:</b>	21"
<b>Mounting Hardware:</b>	Part # 64090012 included for countertops up to 3/4" (19mm) thick
<b>Cutout Template #:</b>	<a href="#">1000001272</a>

Template is available for download at [elkay.com](http://elkay.com). CAD software will be required to open the template.

**Cutout Dimensions for Drop-in Installation:**

16-3/8" x 19-3/8" (416mm x 492mm) with 1-1/2" (38mm) corner radius

<b>Custom Options</b>	
<input type="checkbox"/> Type 316 Stainless Steel	
<b>Drain Location</b>	
<input type="checkbox"/> Right Rear	<input type="checkbox"/> Left Rear
<input type="checkbox"/> Center	<input type="checkbox"/> Center Rear
<b>Overflow Location</b>	
<input type="checkbox"/> Front	<input type="checkbox"/> Rear
<b>Alternate Punching</b>	
<input type="checkbox"/> Faucet Model:	<input type="checkbox"/> Punch Required:
<b>Sink Size</b>	
<input type="checkbox"/> Bowl Depth:	<input type="checkbox"/> Drainboard Width:

**Hole Drilling Configurations:**

1-1/2" (38mm) Diameter Faucet Holes on 4" (102mm) Centers

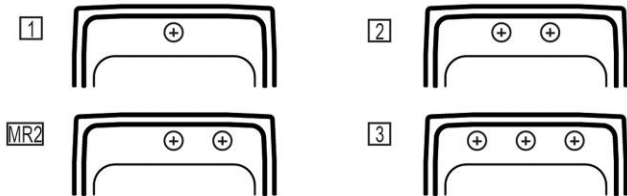

PART: \_\_\_\_\_ QTY: \_\_\_\_\_

PROJECT: \_\_\_\_\_

CONTACT: \_\_\_\_\_

DATE: \_\_\_\_\_

NOTES: \_\_\_\_\_

APPROVAL: \_\_\_\_\_



AMERICAN PRIDE. A LIFETIME TRADITION. Like your family, the Elkay family has values and traditions that endure. For almost a century, Elkay has been a family-owned and operated company, providing thousands of jobs that support our families and communities.



**Product Compliance:** ADA & ICC A117.1  
ASME A112.19.3/CSA B45.4  
BUY AMERICAN ACT



Sinks are listed by IAPMO® as meeting the applicable requirements of the Uniform Plumbing Code®, International Plumbing Code®, and National Plumbing Code of Canada.



Complies with ADA & ICC A117.1 accessibility requirements when installed according to the requirements outlined in these standards.

[Clean and Care Manual \(PDF\)](#)  
[Installation Instructions \(PDF\)](#)  
[Warranty \(PDF\)](#)

**Similar models are available with:** Quick-Clip Mounting System, additional ADA depths

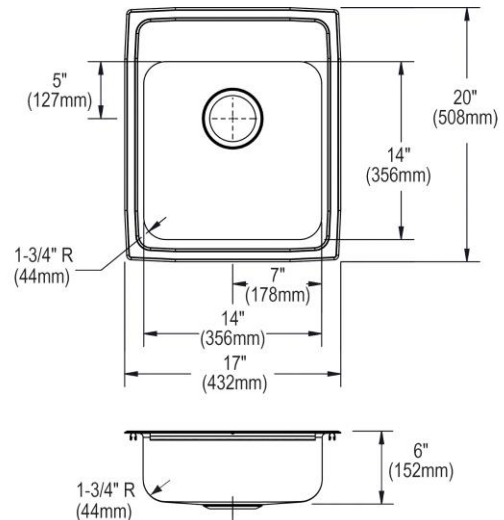

In keeping with our policy of continuing product improvement, Elkay reserves the right to change product specifications without notice. Please visit [elkay.com](http://elkay.com) for the most current version of Elkay product specification sheets. This specification describes an Elkay product with design, quality, and functional benefits to the user. When making a comparison of other producers' offerings, be certain these features are not overlooked.

**Installation Profile:**



**OPTIONAL ACCESSORIES**

<b>Cutting Board:</b>	CB1613
<b>Drain:</b>	LK99, LKAD35
<b>Faucet:</b>	LKGT1041CR, LKGT1041NK, LKGT1041RB
<b>Hardware:</b>	LK364, LK463
<b>Rinsing Basket:</b>	LKWRB1414SS
<b>Soap Dispenser:</b>	LKGT1054

*In keeping with our policy of continuing product improvement, Elkay reserves the right to change product specifications without notice. Please visit [elkay.com](http://elkay.com) for the most current version of Elkay product specification sheets. This specification describes an Elkay product with design, quality, and functional benefits to the user. When making a comparison of other producers' offerings, be certain these features are not overlooked.*