

SA-3636 36" x 36" x 72" Veritek Shower Alcove Wall

Model number:

SA03636

Dimensions: 36" x 36" x 72"

Installation: Direct to Stud

Material: Veritek



Standard Features:

- Nails directly to studs for fast installation.
- Sturdy interlocking system for one-piece appearance.
- Panels easily fit through existing doorways and can be installed by one person.
- Made of Veritek™ with no surface coating to chip or crack - color runs throughout.
- The SA Series is a 3-piece compression molded composite material with molded-in color and a natural gloss surface.

Product characteristics:

- Built-in shelves
- Direct to Stud Installation
- Bestseller

Warranty:

Lifetime limited

Standard colors:



White (010)



Bisque (018)

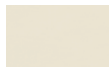

Bone (037)

Certifications

Swan products adhere to one or more of the following certifications:



SA-3636 36" x 36" x 72" Veritek Shower Alcove Wall

Model number: SA03636

Dimensions: 36" x 36" x 72" **Installation:** Direct to Stud

Material: Veritek

Dimensions:

36 x 36 x 72 in.

Weight:

84 lbs

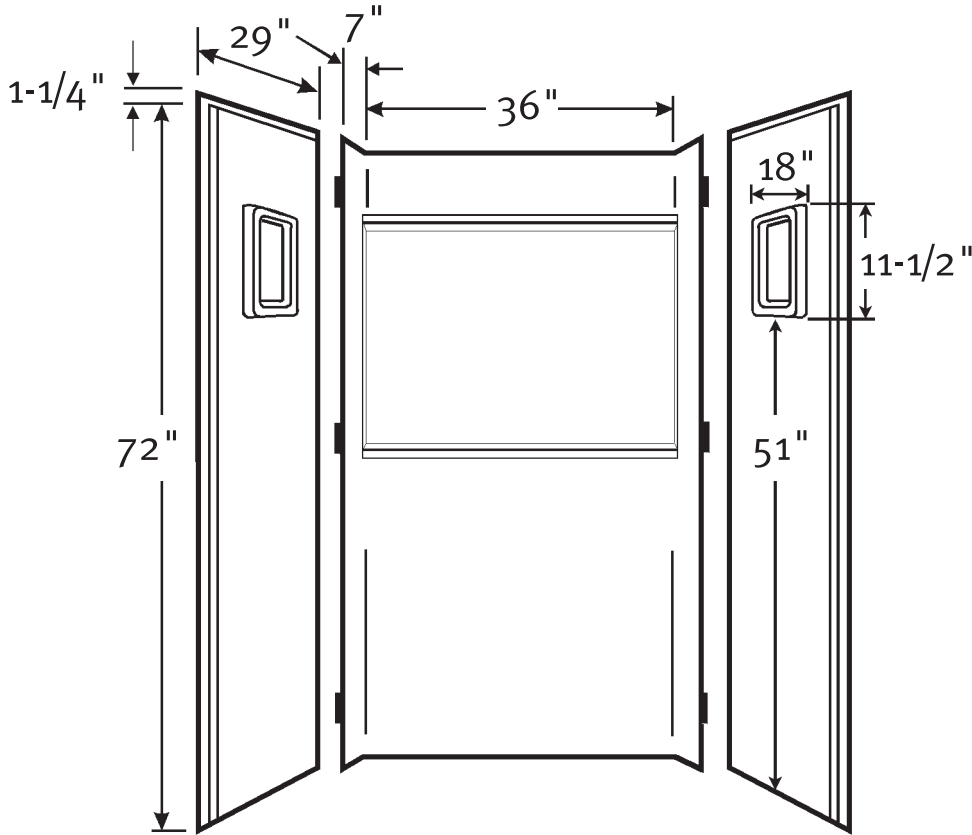

Project:

Contractor:

Representative:

Date:

Tel:

Notes: