

Maris Dual Mount Sink - MAG61023-MBK | 114.0687.044

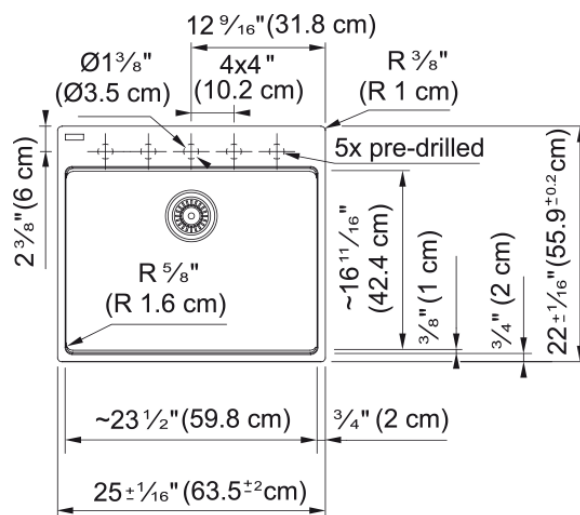

25.0-in. x 22.0-in. Dual Mount Fraganite Single Bowl Kitchen Sink in Matte Black. Maris sinks are equipped with deep capacity bowls that can easily fit baking trays, pots, and pans to be washed with maximum ease. With our easy-to-use integrated ledge system, you'll accomplish more with your sink while making the most of your surrounding counter space. The rear drain maximizes the usable surface of the bowl and creates extra cabinet space beneath the sink. Maris Fraganite sinks are scratch-resistant, fade-resistant, and impact resistant and will retain their new appearance for years.

Aspect

Sink type	Sink
Type of material	Fragranite
Number of bowls	1
Product color	Matte black
Surface finish	None

Product Dimensions

Length (right to left)	25
Width (front to back)	22.008
Large bowl size: right to left	23.465
Large bowl size: front to back	16.614
Large bowl: depth	9.488

Installation

Minimum cabinet size	27"
----------------------	-----

Product specifications

Installation type	Topmount / drop in
Installation type	Undermount
Drain hole	3 1/2"
Position of drainer	No drainer
Active Twist Compatibility	No
Installation device	Fast-Fix Clips

Product identification

Brand	FRANKE
Product family	Maris
Collection	Maris
Certified by	IAPMO

Features

Drainers number	No drainer
Product reversibility	No
Faucet ledge	Yes
Strainer assembly included	No
Strainer Assembly	No waste kit
Overflow	No
Number of faucet holes	5 - pre-scored
Soap dispenser hole	No