

# SK-366296

## Swanstone Shower Wall Kit



### Manufactured from Swanstone Solid Surface

Recommended for high-use traffic areas and commercial surfaces.

### FEATURES

- Reinforced solid surface means color and texture run all the way through and cannot wear away.
- Will not mold or mildew, no grout to clean.
- Ideal for remodeling, panels glue up over existing surface.
- Coordinates with other Swanstone bath products.
- A complete kit with everything you need to design your shower.
- Wall panels are easily trimmed to fit shower applications.
- Heat resistant—walls can handle steamer units.
- Compression molding means superior durability.
- Warranty: Limited Lifetime – Residential  
Limited 30-year – Commercial

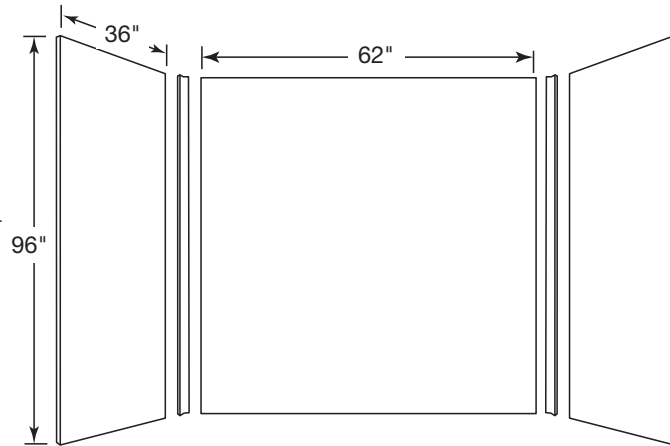

Designed to fit base areas  
36" deep or smaller x 62" wide x 96" high or smaller  
(914 mm x 1575 mm x 2438 mm)



**ES-2**  
Soap Shelves  
Included

- The **SK-366296** is a five piece shower wall panel system with a smooth surface.

### SPECIFICATIONS

Model	Part	Ship Wt. Lb.	Carton Dims. In.	Cu. Ft.
SK-366296	SK366296	288	103 x 68 x 4	16.2

**Kit Includes:** Two side panels, one back panel, two corner molding strips, two corner soap shelves.

**Packaging:** Each kit is packed in an individual carton.

### COLORS

#### Solid Colors:

- White (010)
- Bisque (018)
- Bone (037)

#### Aggregate Colors:

- Bermuda Sand (040)
- Black Galaxy (015)
- Carrara (221)
- Concrete Ash Gray (203)
- Concrete Birch (226)
- Concrete Charcoal Gray (209)
- Concrete Clay (212)
- Concrete Limestone (218)
- Concrete Sandstone (215)
- Ice (130)
- Tahiti White (011)

### ACCESSORIES

See page 56 for complete listing of all wall accessories.

### STANDARDS AND RATINGS

American Society of Testing and Materials (ASTM) E-84: Class A Flame Spread Rating

American National Standard Institute—ANSI Z124.6

International Association of Plumbing and Mechanical Officials (IAPMO)—Listed

cUPC listed—Certified to CSA Test Standard B45.5 by IAPMO

Uniform Plumbing Code (UPC)

For a complete list of tests and results see the Technical Data Sheet.

### MAINTENANCE AND CLEANING INFORMATION

Clean regularly with common household liquid cleaners and rinse within five minutes of application. Occasional scrubbing with abrasive cleaners ensures that the original luster will be maintained. **Do not** use "leave on" cleaning products, such as automatic spray shower cleaners. Prolonged contact with harsh chemicals could have an adverse reaction over time and discolor surfaces.

**Do not** use cleaning agents that caution use on acrylic, polyester or plastics.

### SUPPORT DOCUMENTS

Installation instructions available at [swanstone.com](http://swanstone.com).

**MADE IN USA**