

VERSAILLES 7236

DESIGNER COLLECTION

H | S

PVC SYSTEMS INCLUDE:

- 6 Fully directional adjustable flow PVC jets
- Anti-vortex safety suction
- Color matched system trim
- HydroOzone ozone sanitation system
- Rigid PVC piping
- Self draining pump and system
- Soft Touch electronic on/off control with 30-minute integral times
- 2.25 HP single speed pump
- Cable waste and overflow



Standard Grab Bar



Linear Integral Waste and Overflow

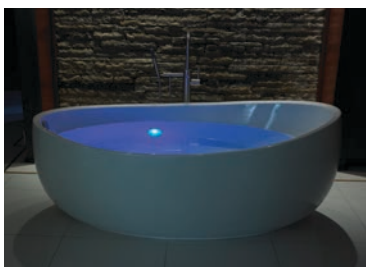

Chromatherapy-LED Lighting System

OPTIONS: [\(MORE INFORMATION AVAILABLE ON OUR WEBSITE\)](#)

- Additional Jets
 - Directional or Swirling
- Back Masseuse Systems
- Chromatherapy-LED Lighting System
- Custom Jet and Pump Location
- Electronic Low Water Protection
- Extra High Density
- Grab Bars
 - Standard or Universal
- Hydro Coat
- Hydro Express Quick Ship
- Hydro Fusion
- Hydro Indulge
- HydrOzone UV System
- In-line Heater
- Integral Waste and Overflow
 - Round or Linear
- Jumbo Jets
 - Directional or Rotating
- Micro Mount
- Micro Therapy Jets
- Molded Armrests
- Neck Masseuse Pillow
- Skirt (1-4 sided)
- Tile Flanges (1-4 sided)

STANDARD ELECTRICAL REQUIREMENTS:

- Whirlpool System | One 20 Amp Dedicated Circuit
- Thermal Air System | One 15 Amp Dedicated Circuit
- Combo System | One 15 Amp Dedicated Circuit and One 20 Amp Dedicated Circuit
- Indulge System | One 15 Amp Dedicated Circuit
- Hydro Fusion (600 or 1500 Watts) | One 15 Amp Dedicated Circuit
- Inline Heater (600 or 1500 Watts) | One 15 Amp Dedicated Circuit

All electrical components come standard at 115 volts

All electrical circuits must be GFCI protected

HYDRO SYSTEMS
Family Owned And Operated Since 1978

29132 Avenue Paine, Valencia, CA, 91355
661.775.0686 | hydrosystem.com



MADE IN AMERICA

** Indicates options that are shown (listed in order from top to bottom/ left to right)*

VERSAILLES 7236

H|S

DESIGNER COLLECTION

As SHOWN:

Whirlpool option

FEATURES SHOWN:

- Overflow location
- Hidden drain cover
- Standard jet location

ALSO AVAILABLE:

- Soaking tub only
- Thermal Air
- Combo

BACKSLOPE:

24 degrees

WATER CAPACITY:

80 Gallons

WEIGHT:

160-200 Pounds depending on system

DROP-IN INSTALLATION DIMENSIONS:

- (L)ength- 70"
- (W)idth- 34"
- (H)eight- 19-1/2"

3-WALL INSTALLATION DIMENSIONS:

- (L)ength- 72"
- (W)idth- 36"
- Top of Ledger- 21-1/2"

INSTALLATION TIPS:

- When adding integral linear drain p-trap location is now below waste
- Adding multiple systems/options may require equipment to stick out from tub deck or be installed remotely

CODES AND COMPLIANCES

Massachusetts code File no: P1-0614-491



ACRYLIC TUB

- Acrylic models finished in 1/8" thick layer of deep lustrous acrylic
- Pre-wired pump on pump platform (standard pump location only)
- Integral E-Z level platform facilitates installation
- Micro mount reduces lip height by approximately 3/8" to 5/8"
- Micro mount requires increase in framing height by an additional 1-1/4"

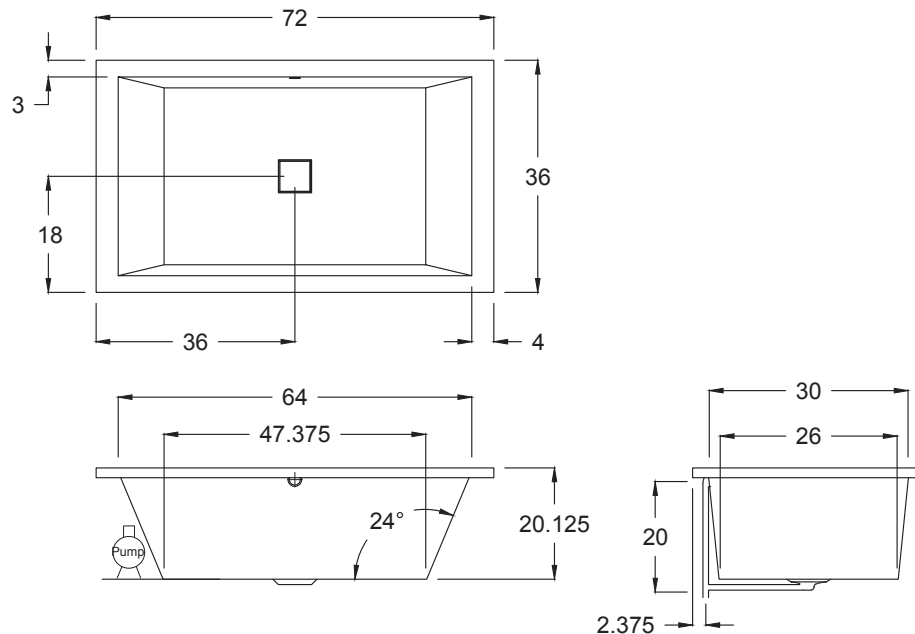

HYDRO SYSTEMS
Family Owned And Operated Since 1978

29132 Avenue Paine, Valencia, CA, 91355
661.775.0686 | hydrosystem.com



MADE IN AMERICA

All specifications and options subject to change without notice please contact a Hydro Systems representative for more information. Certain options or altering the pump/blower location may cause the pump/blower to extend beyond the tub decking. For cutout dimensions wait for unit to arrive. All specifications subject to change without notice.